

R5050BC-B4-1B

5.0×5.0mm, Blue LED

Surface Mount PLCC-6 LED Indicator



Technical Data Sheet

Features:

- PLCC-6 package.
- White package.
- High reliability package with silicone encapsulation.
- Ideal for backlight and light pipe application.
- Suitable for reflow and wave solder processes.
- The product itself will remain within RoHS compliant version.

Descriptions:

- The R5050 SMT LEDs is packaged in the industry standard PLCC-6 package. These SMT LEDs have high reliability performance and are designed to work under a wide range of environmental conditions. This high reliability feature makes them ideally suited to be used as interior signs application conditions.
- To facilitate easy pick & place assembly, the LEDs are packed in EIA-compliant tape and reel. Every reel will be shipped in single intensity and color bin.
- The wide viewing angle at 120° makes these LEDs ideally suited for panel, push button, industrial equipment, and home appliances. The flat top emitting surface makes it easy for these LEDs to mate with light pipes. With the built-in reflector pushing up the intensity of the light output, these LEDs are also suitable to be used as LED pixels in interior electronic signs.

Applications:

- Non-automotive use.
- General Signage backlighting.
- Amusement machine backlighting.
- Industrial lighting.
- Light strips.

R5050BC-B4-1B

5.0×5.0mm, Blue LED

Surface Mount PLCC-6 LED Indicator



Technical Data Sheet

Part No.	Emitting Color	Lens Color
R5050BC-B4-1B	Blue	Water Clear

Package Dimension:

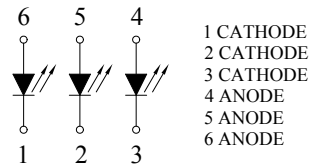
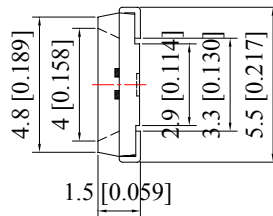
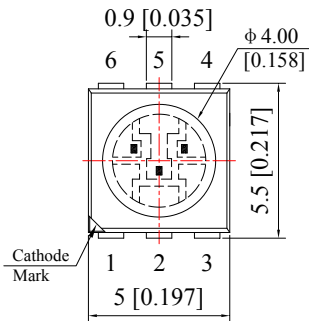

Polarity

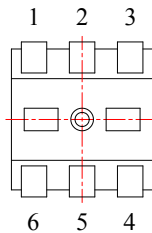
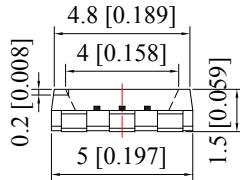

Recommended Soldering Pad dimensions

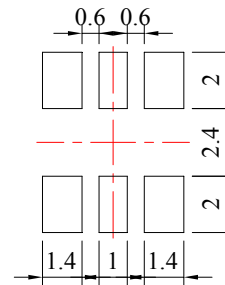

Unit: mm
Tolerance: ± 0.10mm

Notes:

1. All dimensions are in millimeters (inches).
2. Tolerance is ± 0.25 mm (.010") unless otherwise noted.

R5050BC-B4-1B

5.0×5.0mm, Blue LED

Surface Mount PLCC-6 LED Indicator

LuckyLight

Technical Data Sheet

Absolute Maximum Ratings at Ta=25°C

Parameters	Symbol	Max.	Unit
Power Dissipation	P_d	90×3	mW
Peak Forward Current ^(a)	I_{FP}	100×3	mA
DC Forward Current ^(b)	I_F	25×3	mA
Reverse Voltage	V_R	5	V
Electrostatic Discharge (HBM)	ESD	1000	V
Operating Temperature Range	T_{opr}	-40°C to +80°C	
Storage Temperature Range	T_{stg}	-40°C to +85°C	
Soldering Temperature	T_{sld}	260°C for 5 Seconds	

Notes:

- Derate linearly as shown in derating curve.
- Duty Factor = 10%, Frequency = 1 kHz.

Electrical Optical Characteristics at Ta=25°C

Parameters	Symbol	Min.	Typ.	Max.	Unit	Test Condition
Luminous Intensity ^(a)	I_V	800	1200	---	mcd	IF=20mA×3=60mA
Viewing Angle ^(b)	$2\theta_{1/2}$	---	120	---	Deg	IF=20mA×3=60mA
Peak Emission Wavelength	λ_p	---	468	---	nm	IF=20mA×3=60mA
Dominant Wavelength ^(c)	λ_d	---	470	---	nm	IF=20mA×3=60mA
Spectral Line Half-Width	$\Delta\lambda$	---	25	---	nm	IF=20mA×3=60mA
Forward Voltage	V_F	2.80	3.20	3.60	V	IF=20mA×3=60mA
Reverse Current	I_R	---	---	10	μA	VR=5V

Notes:

- Luminous intensity is measured with a light sensor and filter combination that approximates the CIE eye-response curve.
- $2\theta_{1/2}$ is the o-axis angle where the luminous intensity is 1/2 the peak intensity.
- The dominant wavelength (λ_d) is derived from the CIE chromaticity diagram and represents the single wavelength which defines the color of the device.

R5050BC-B4-1B

5.0×5.0mm, Blue LED

Surface Mount PLCC-6 LED Indicator



Technical Data Sheet

Typical Electrical / Optical Characteristics Curves

(25°C Ambient Temperature Unless Otherwise Noted)

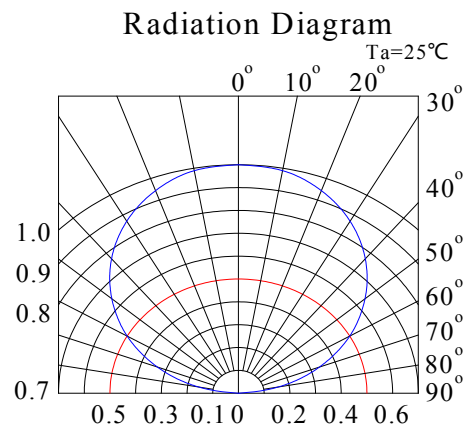
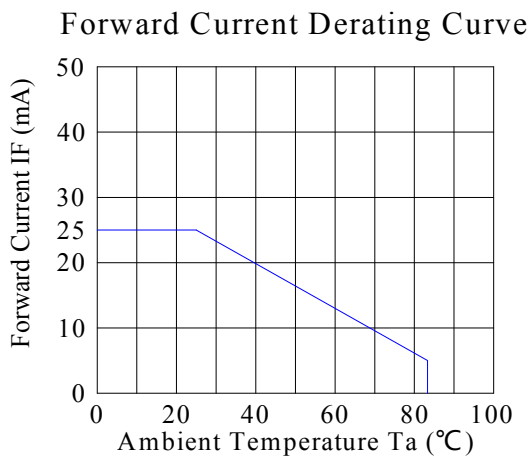
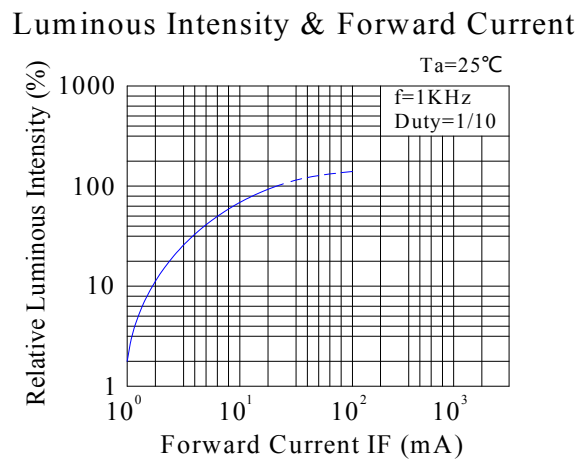
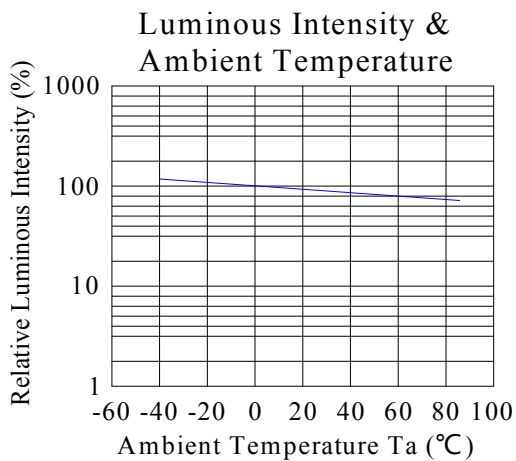
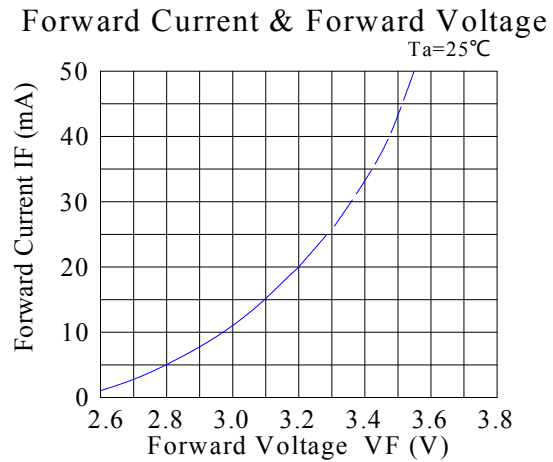
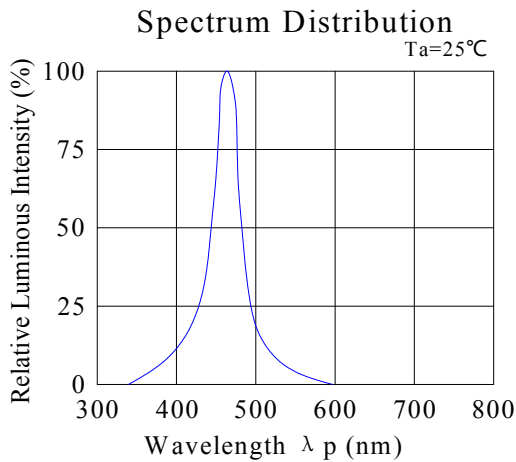

R5050BC-B4-1B

5.0×5.0mm, Blue LED

Surface Mount PLCC-6 LED Indicator



Technical Data Sheet

Reel Dimensions:

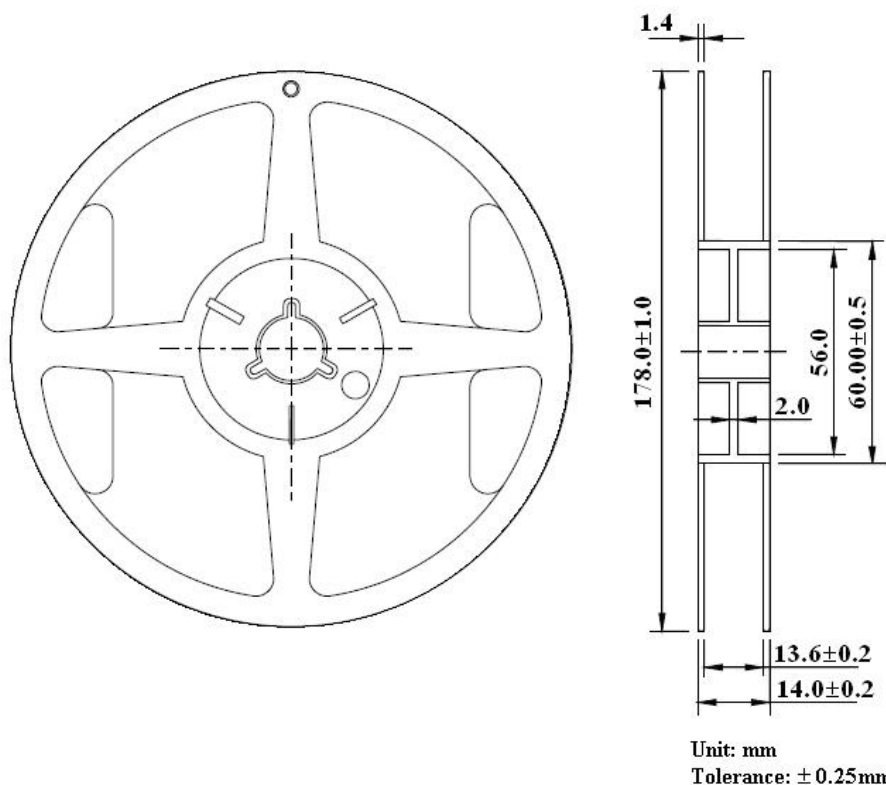

Carrier Tape Dimensions:

Loaded quantity 1000PCS per reel.

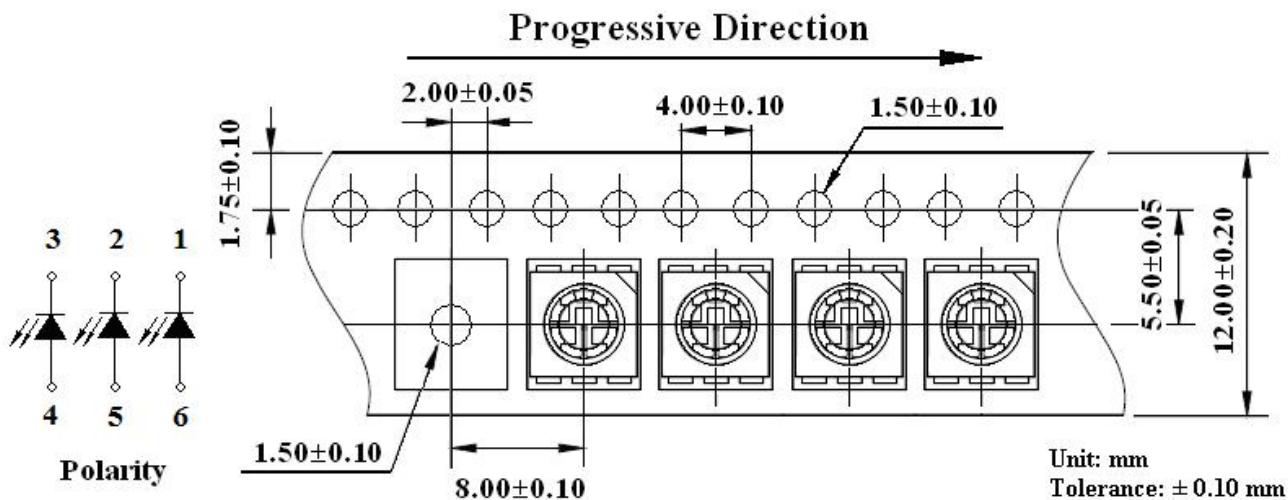

R5050BC-B4-1B

5.0×5.0mm, Blue LED

Surface Mount PLCC-6 LED Indicator



Technical Data Sheet

Packing & Label Specifications:

Moisture Resistant Packaging:

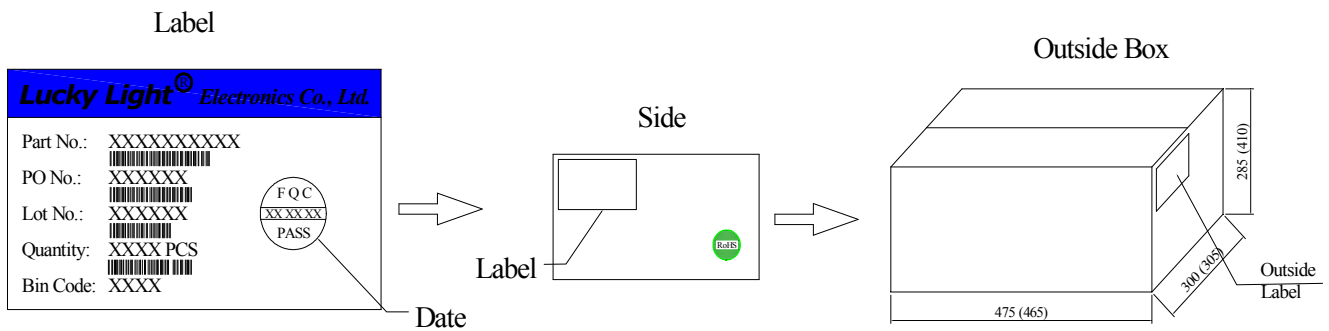
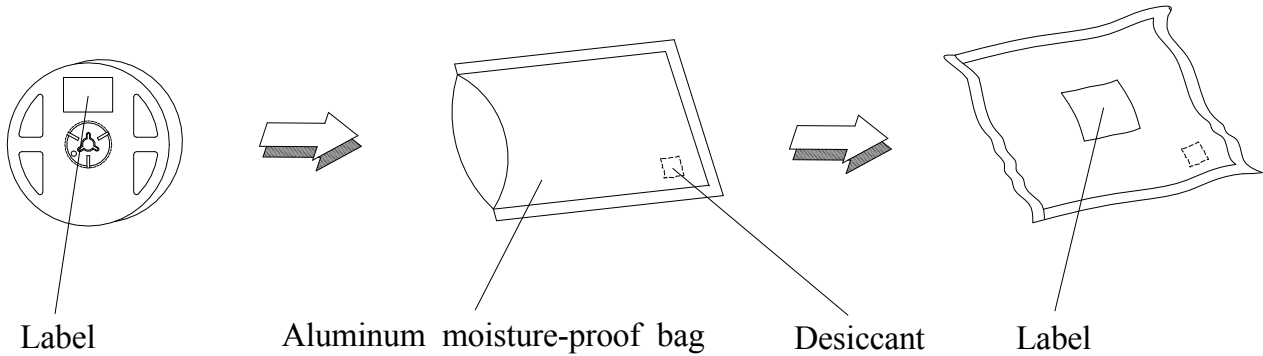

R5050BC-B4-1B

5.0×5.0mm, Blue LED

Surface Mount PLCC-6 LED Indicator

LuckyLight

Technical Data Sheet

CAUTIONS

1. Handling Precautions:

- 1.1 Handle the component along the side surfaces by using forceps or appropriate tools.
- 1.2 Do not directly touch or handle the silicone lens surface. It may damage the internal circuitry.
- 1.3 Do not stack together assembled PCBs containing exposed LEDs. Impact may scratch the silicone lens or damage the internal circuitry.

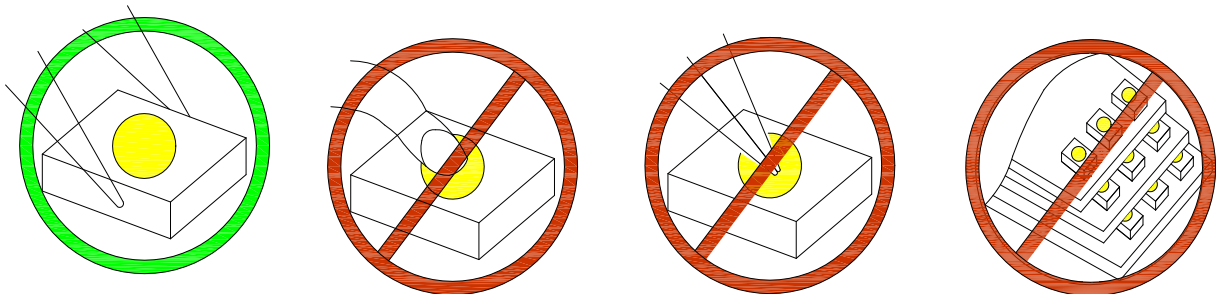

1.4 Compare to epoxy encapsulant that is hard and brittle, silicone is softer and flexible. Although its characteristic significantly reduces thermal stress, it is more susceptible to damage by external mechanical force. As a result, special handling precautions need to be observed during assembly using silicone encapsulated LED products. Failure to comply might lead to damage and premature failure of the LED.

2. Storage:

- 2.1 Do not open moisture proof bag before the products are ready to use.
- 2.2 Before opening the package, the LEDs should be kept at 30°C or less and 60%RH or less.
- 2.3 The LEDs should be used within a year.
- 2.4 After opening the package, the LEDs should be kept at 30°C or less and 60%RH or less.
- 2.5 The LEDs should be used within 24 hours after opening the package.
- 2.6 If the moisture adsorbent material has fabled away or the LEDs have exceeded the storage time, baking treatment should be performed using the following conditions. Baking treatment: 65±5°C for 24 hours.

R5050BC-B4-1B

5.0×5.0mm, Blue LED

Surface Mount PLCC-6 LED Indicator



Technical Data Sheet

3. Soldering Condition:

3.1 Pb-free solder temperature profile.

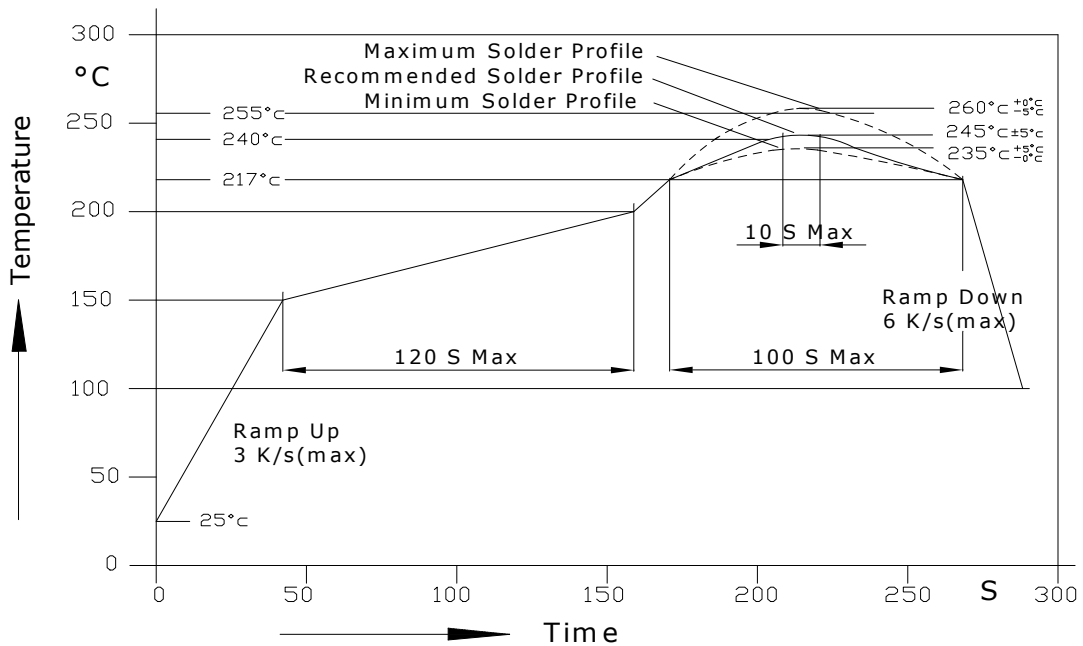

3.2 Reflow soldering should not be done more than two times.

3.3 When soldering, do not put stress on the LEDs during heating.

3.4 After soldering, do not warp the circuit board.

3.5 Recommended soldering conditions:

Reflow soldering		Soldering iron	
Pre-heat	150~200°C	Temperature	300°C Max.
Pre-heat time	120 sec. Max.	Soldering time	3 sec. Max.
Peak temperature	260°C Max.		(one time only)
Soldering time	10 sec. Max. (Max. two times)		

3.6 Because different board designs use different number and types of devices, solder pastes, reflow ovens, and circuit boards, no single temperature profile works for all possible combinations.

However, you can successfully mount your packages to the PCB by following the proper guidelines and PCB-specific characterization.

R5050BC-B4-1B

5.0×5.0mm, Blue LED

Surface Mount PLCC-6 LED Indicator

LuckyLight

Technical Data Sheet

4. Drive Method:

4.1 An LED is a current-operated device. In order to ensure intensity uniformity on multiple LEDs connected in parallel in an application, it is recommended that a current limiting resistor be incorporated in the drive circuit, in series with each LED as shown in Circuit A below.

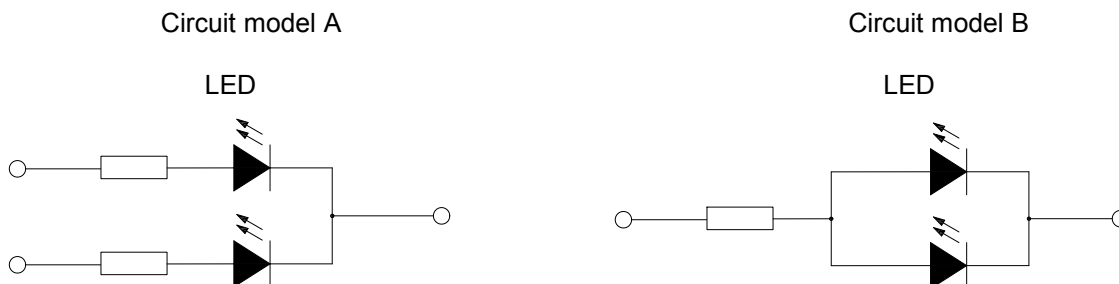

(A) Recommended circuit.

(B) The brightness of each LED might appear different due to the differences in the I-V characteristics of those LEDs.

5. ESD (Electrostatic Discharge):

Static Electricity or power surge will damage the LED. Suggestions to prevent ESD damage:

- Use of a conductive wrist band or anti-electrostatic glove when handling these LEDs.
- All devices, equipment, and machinery must be properly grounded.
- Work tables, storage racks, etc. should be properly grounded.
- Use ion blower to neutralize the static charge which might have built up on surface of the LED's plastic lens as a result of friction between LEDs during storage and handling.

ESD-damaged LEDs will exhibit abnormal characteristics such as high reverse leakage current, low forward voltage, or "no lightup" at low currents. To verify for ESD damage, check for "lightup" and V_f of the suspect LEDs at low currents. The V_f of "good" LEDs should be $>2.0V@0.1mA$ for InGaN product and $>1.4V@0.1mA$ for AlInGaP product.

R5050BC-B4-1B

5.0×5.0mm, Blue LED

Surface Mount PLCC-6 LED Indicator



Technical Data Sheet

Terms and conditions for the usage of this document:

1. The information included in this document reflects representative usage scenarios and is intended for technical reference only.
2. The part number, type, and specifications mentioned in this document are subject to future change and improvement without notice. Before production usage customer should refer to the latest datasheet for the updated specifications.
3. When using the products referenced in this document, please make sure the product is being operated within the environmental and electrical limits specified in the datasheet. If customer usage exceeds the specified limits, LuckyLight will not be responsible for any subsequent issues.
4. The information in this document applies to typical usage in consumer electronics applications. If customer's application has special reliability requirements or have life-threatening liabilities, such as automotive or medical usage, please consult with LuckyLight representative for further assistance.
5. The contents and information of this document may not be reproduced or re-transmitted without permission by LuckyLight.