

## R3014W-W2N-Q24-RA80

3.0x1.4mm,White LED

Surface Mount PLCC-2 LED

## Technical Data Sheet

---

### Features:

- Industry standard PLCC-2 package.
- High reliability LED Package
- Inter reflector.
- Available in full selection of colors.
- Suitable for automatic placement equipment.
- Suitable for vapor-phase reflow, Infrared reflow and wave solder processes.
- Available on tape and reel
- The product itself will remain within RoHS compliant Version.



### Descriptions:

- The R3014 series is available in soft red, orange, yellow, green, blue and white. Due to the package design, the LED has wide viewing angle and optimized light coupling by inter reflector. This feature makes the SMT TOP LED ideal for light pipe application. The low current requirement makes this device ideal for portable equipment or any other application where power is at a premium.

### Applications:

- Instrument panel backlighting
- Switch push button backlighting
- Electronic signs and signals
- Variable message sign
- Office automation,home appliances,industrial equipment
- Front panel backlighting
- Push button backlighting
- Display backlighting
- Reading lights
- Indoor and outdoor commercial lighting

# R3014W-W2N-Q24-RA80

3.0x1.4mm, White LED

Surface Mount PLCC-2 LED

## Technical Data Sheet

Part No.	Emitting Color	Lens Color
R3014W-W2N-Q24-RA80	White	Yellow Diffused

### Package Dimension:

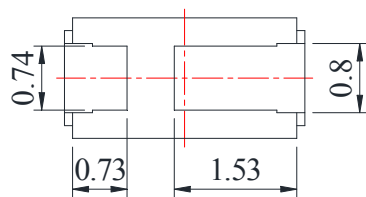
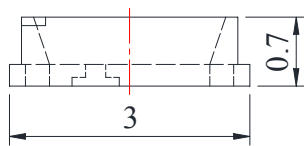
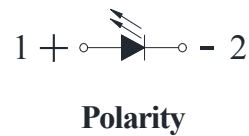
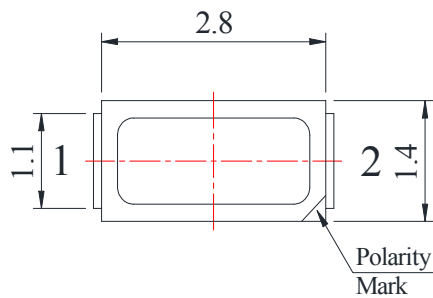

### Recommended Soldering Pad Dimensions

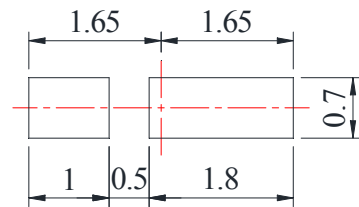

Unit: mm  
Tolerance:  $\pm 0.10\text{mm}$

### Notes:

1. All dimensions are in millimeters (inches).
2. Tolerance is  $\pm 0.25\text{ mm}$  (.010") unless otherwise noted.

# R3014W-W2N-Q24-RA80

3.0x1.4mm, White LED

Surface Mount PLCC-2 LED

## Technical Data Sheet

### Absolute Maximum Ratings at Ta=25°C

Parameters	Symbol	Max	Unit
Power Dissipation	Pd	221	mW
Peak Forward Current <sup>(a)</sup>	IFP	150	mA
DC Forward Current	IF	65	mA
Reverse Voltage	VR	5	V
Electrostatic Discharge (HBM)	ESD	1000	V
Operating Temperature Range	Topr	-40°C to +85°C	
Storage Temperature Range	Tstg	-40°C to +85°C	
Soldering Temperature	Tsld	260°C for 5 Seconds	

Notes:

a. Duty Factor = 10%, Frequency = 1 kHz

### Electrical Optical Characteristics at Ta=25°C

Parameters	Symbol	Min.	Typ.	Max.	Unit	Test Condition
Luminous Flux <sup>(a)</sup>	$\Phi_v$	24	26	---	Lm	IF=65mA
Viewing Angle	2 $\theta$ 1/2	---	120	---	Deg	IF=65mA
Chromaticity Coordinates <sup>(b)</sup>	x	---	0.31	---		IF=65mA
	y	---	0.32	---		
Color Temperature	CCT	5000	6500	7000	K	IF=65mA
Color Rendering Index	CRI	80	---	---	Ra	IF=65mA
Forward Voltage <sup>(c)</sup>	VF	2.80	3.10	3.40	V	IF=65mA
Reverse Current	IR	---	---	10	$\mu$ A	VR=5V

a. Luminous flux measurement tolerance:  $\pm 10\%$ .

b. Color coordinates measurement tolerance:  $\pm 0.015$

c. Forward voltage measurement tolerance:  $\pm 0.1V$

# R3014W-W2N-Q24-RA80

3.0x1.4mm, White LED

Surface Mount PLCC-2 LED



## Technical Data Sheet

### Typical Electrical / Optical Characteristics Curves (25°C Ambient Temperature Unless Otherwise Noted)

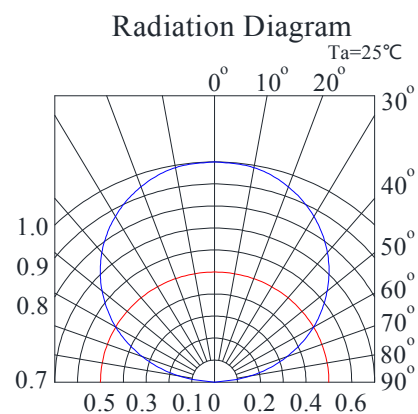
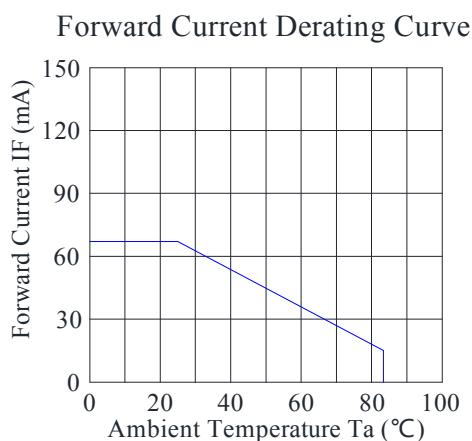
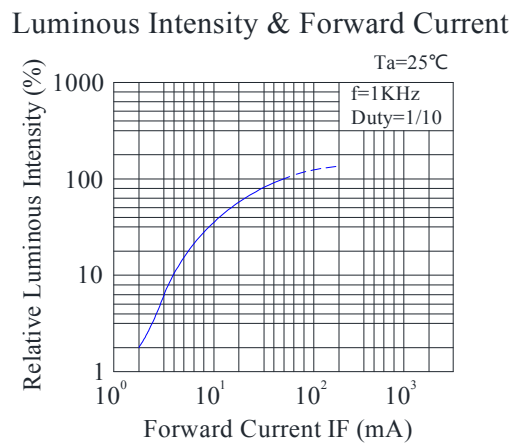
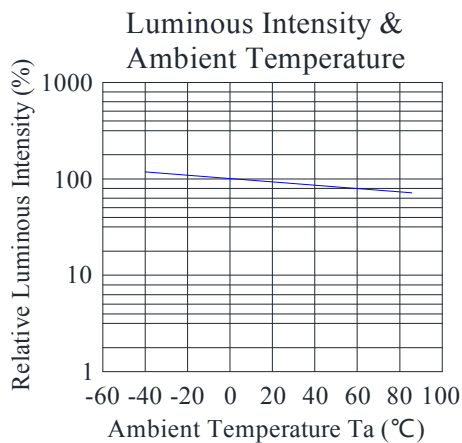
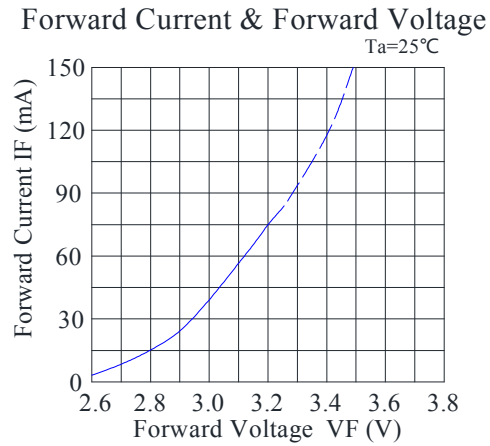
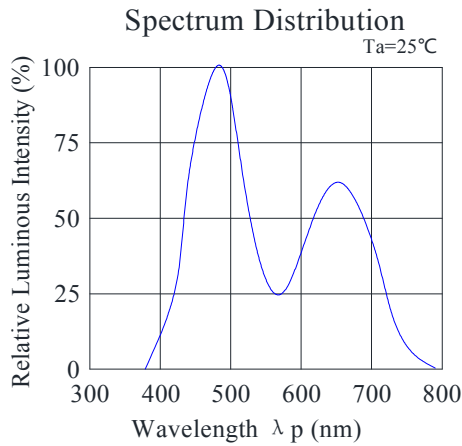

# R3014W-W2N-Q24-RA80

3.0x1.4mm, White LED

Surface Mount PLCC-2 LED



## Technical Data Sheet

### CIE 1931 Chromaticity Diagram:

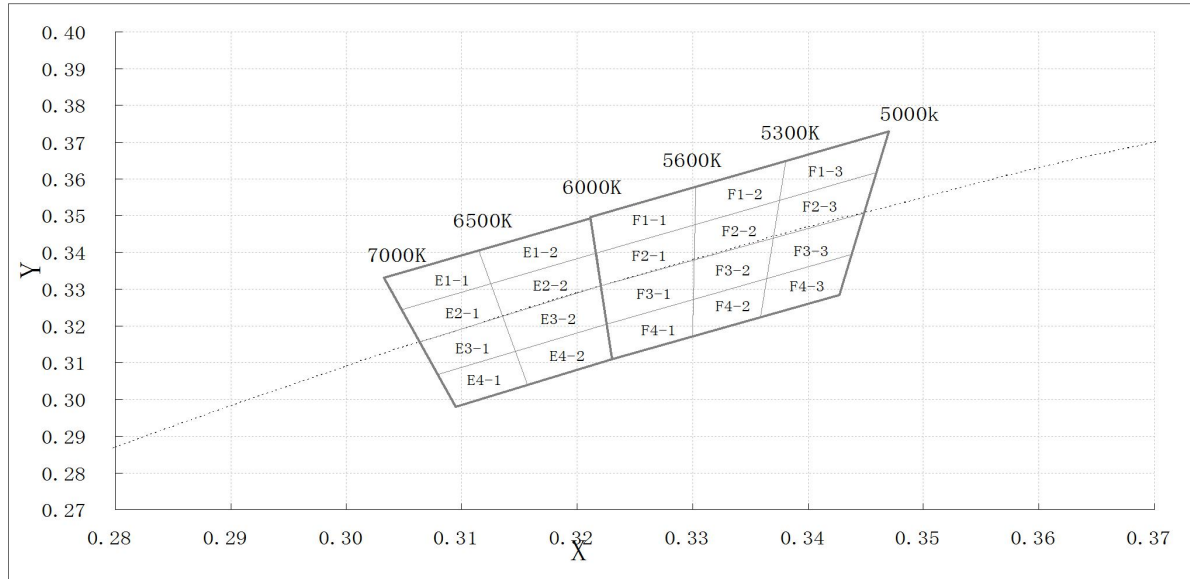

### Chromaticity Coordinates Specifications for Bin Rank:

Bin Code	Left x	Left y	Top x	Top y	Right x	Right y	Bottom x	Bottom y
E1-1	0.305	0.324	0.313	0.331	0.312	0.341	0.303	0.333
E2-1	0.306	0.316	0.314	0.323	0.313	0.331	0.305	0.324
E3-1	0.308	0.307	0.315	0.313	0.314	0.323	0.306	0.316
E4-1	0.310	0.298	0.316	0.304	0.315	0.313	0.308	0.307
E1-2	0.313	0.331	0.323	0.340	0.323	0.349	0.312	0.341
E2-2	0.314	0.323	0.323	0.330	0.323	0.340	0.313	0.331
E3-2	0.315	0.313	0.323	0.321	0.323	0.330	0.314	0.323
E4-2	0.316	0.304	0.323	0.311	0.323	0.321	0.315	0.313
F1-1	0.323	0.340	0.330	0.347	0.330	0.357	0.323	0.349
F2-1	0.323	0.330	0.330	0.337	0.330	0.347	0.323	0.340
F3-1	0.323	0.321	0.330	0.327	0.330	0.337	0.323	0.330
F4-1	0.323	0.311	0.330	0.317	0.330	0.327	0.323	0.321
F1-2	0.330	0.347	0.337	0.354	0.338	0.365	0.330	0.357
F2-2	0.330	0.337	0.337	0.343	0.337	0.354	0.330	0.347
F3-2	0.330	0.327	0.337	0.333	0.337	0.343	0.330	0.337
F4-2	0.330	0.317	0.337	0.322	0.337	0.333	0.330	0.327
F1-3	0.337	0.354	0.346	0.362	0.347	0.373	0.338	0.365
F2-3	0.337	0.343	0.345	0.351	0.346	0.362	0.337	0.354
F3-3	0.337	0.333	0.344	0.340	0.345	0.351	0.337	0.343
F4-3	0.337	0.322	0.343	0.328	0.344	0.340	0.337	0.333

Notes:

Spec No.: R3014

Issue No.: G-Rev-5

LuckyLight Electronics Co., Ltd

Copyright © 2020 LuckyLight All Rights Reserved

Date: 12-Sep-2020

E-mail: sales@luckylight.cn

http:// www.luckylight.cn

Page: 5 / 11

# R3014W-W2N-Q24-RA80

3.0x1.4mm, White LED

Surface Mount PLCC-2 LED



## Technical Data Sheet

1. Color coordinates measurement allowance is  $\pm 0.15$ .
2. One delivery will include up to two consecutive color ranks and three luminous intensity ranks of the products the quantity-ratio of the ranks is decided by *LuckyLight*.

### Reel Dimensions:

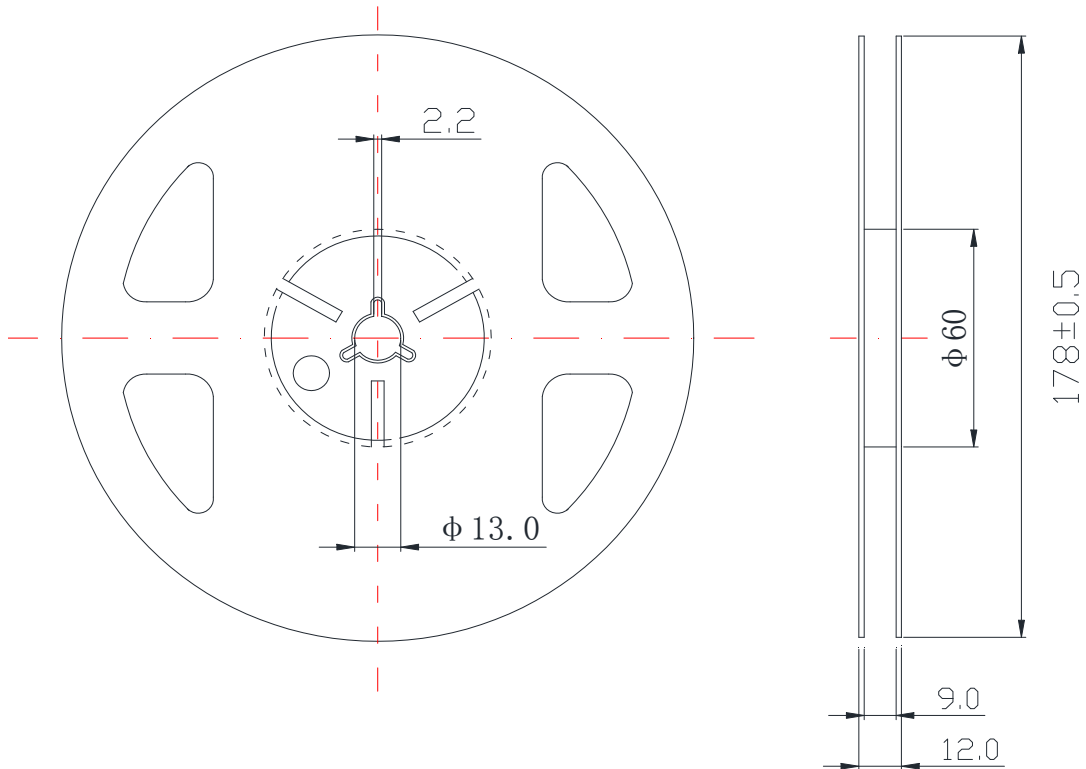

### Carrier Tape Dimensions:

Loaded quantity 4000 pcs per reel.

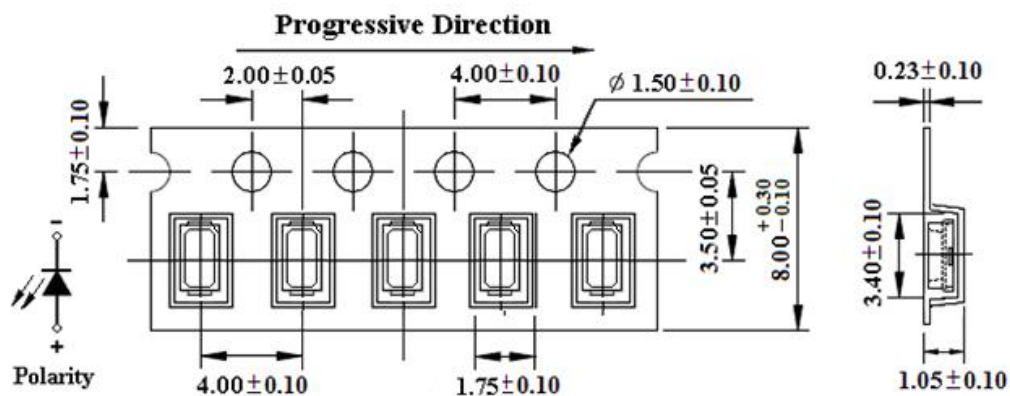

# R3014W-W2N-Q24-RA80

3.0x1.4mm, White LED

Surface Mount PLCC-2 LED



## Technical Data Sheet

### Packing & Label Specifications:

Moisture Resistant Packaging:

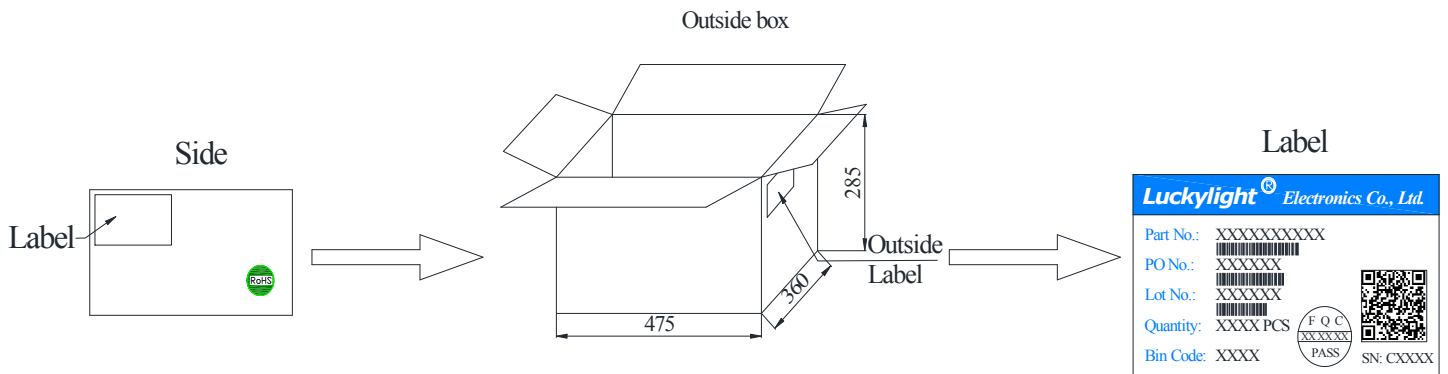
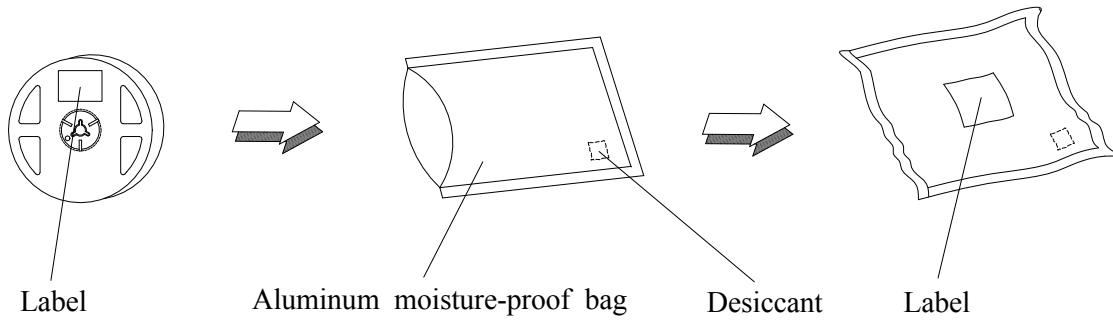

Spec No.: R3014

Issue No.: G-Rev-5

LuckyLight Electronics Co., Ltd

Copyright © 2020 LuckyLight All Rights Reserved

Date: 12-Sep-2020

E-mail: sales@luckylight.cn

http:// www.luckylight.cn

Page: 7 / 11

## R3014W-W2N-Q24-RA80

3.0x1.4mm, White LED

Surface Mount PLCC-2 LED

### Technical Data Sheet

---

#### CAUTIONS

##### 1. Handling Precautions:

- 1.1 Handle the component along the side surfaces by using forceps or appropriate tools.
- 1.2 Do not directly touch or handle the silicone lens surface. It may damage the internal circuitry.
- 1.3 Do not stack together assembled PCBs containing exposed LEDs. Impact may scratch the silicone lens or damage the internal circuitry.

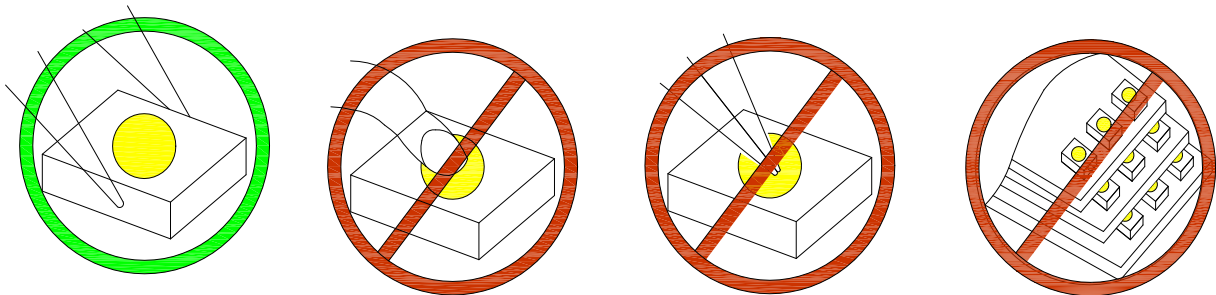

- 1.4 Compare to epoxy encapsulant that is hard and brittle, silicone is softer and flexible. Although its characteristic significantly reduces thermal stress, it is more susceptible to damage by external mechanical force. As a result, special handling precautions need to be observed during assembly using silicone encapsulated LED products. Failure to comply might lead to damage and premature failure of the LED.

##### 2. Storage:

- 2.1 Do not open moisture proof bag before the products are ready to use.
- 2.2 Before opening the package, the LEDs should be kept at 30°C or less and 60%RH or less.
- 2.3 The LEDs should be used within a year.
- 2.4 After opening the package, the LEDs should be kept at 30°C or less and 60%RH or less.
- 2.5 The LEDs should be used within 24 hours after opening the package.
- 2.6 If the moisture adsorbent material has fabled away or the LEDs have exceeded the storage time, baking treatment should be performed using the following conditions. Baking treatment: 65±5°C for 24 hours.



# R3014W-W2N-Q24-RA80

3.0x1.4mm, White LED

Surface Mount PLCC-2 LED



## Technical Data Sheet

### 3. Soldering Condition:

3.1 Pb-free solder temperature profile.

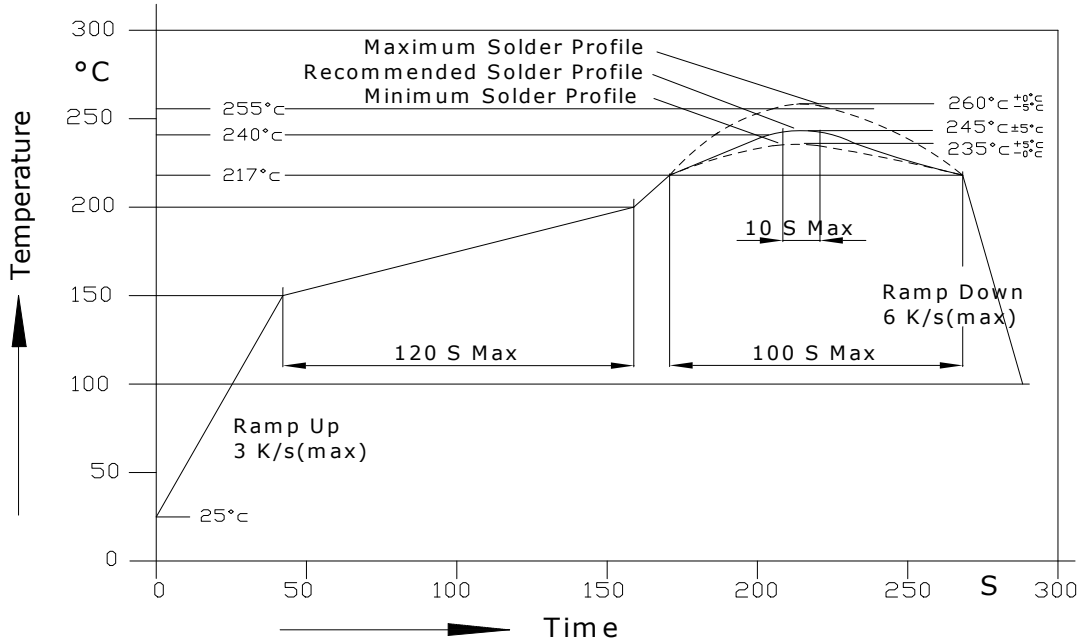

3.2 Reflow soldering should not be done more than two times.

3.3 When soldering, do not put stress on the LEDs during heating.

3.4 After soldering, do not warp the circuit board.

3.5 Recommended soldering conditions:

Reflow soldering		Soldering iron	
Pre-heat	150~200°C	Temperature	300°C Max.
Pre-heat time	120 sec. Max.	Soldering time	3 sec. Max.
Peak temperature	260°C Max.		(one time only)
Soldering time	10 sec. Max. (Max. two times)		

3.6 Because different board designs use different number and types of devices, solder pastes, reflow ovens, and circuit boards, no single temperature profile works for all possible combinations.

However, you can successfully mount your packages to the PCB by following the proper guidelines and PCB-specific characterization.

## R3014W-W2N-Q24-RA80

3.0x1.4mm, White LED

Surface Mount PLCC-2 LED

### Technical Data Sheet

---

#### 4. Drive Method:

4.1 An LED is a current-operated device. In order to ensure intensity uniformity on multiple LEDs connected in parallel in an application, it is recommended that a current limiting resistor be incorporated in the drive circuit, in series with each LED as shown in Circuit A below.

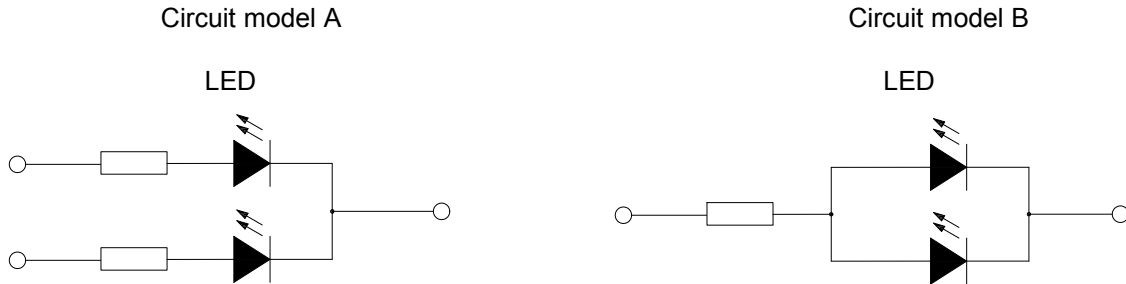

(A) Recommended circuit.

(B) The brightness of each LED might appear different due to the differences in the I-V characteristics of those LEDs.

#### 5. ESD (Electrostatic Discharge):

Static Electricity or power surge will damage the LED. Suggestions to prevent ESD damage:

- Use of a conductive wrist band or anti-electrostatic glove when handling these LEDs.
- All devices, equipment, and machinery must be properly grounded.
- Work tables, storage racks, etc. should be properly grounded.
- Use ion blower to neutralize the static charge which might have built up on surface of the LED's plastic lens as a result of friction between LEDs during storage and handling.

ESD-damaged LEDs will exhibit abnormal characteristics such as high reverse leakage current, low forward voltage, or "no lightup" at low currents. To verify for ESD damage, check for "lightup" and  $V_f$  of the suspect LEDs at low currents. The  $V_f$  of "good" LEDs should be  $>2.0V@0.1mA$  for InGaN product and  $>1.4V@0.1mA$  for AlInGaP product.

## R3014W-W2N-Q24-RA80

3.0x1.4mm,White LED

Surface Mount PLCC-2 LED

**LuckyLight**

### Technical Data Sheet

---

#### Terms and conditions for the usage of this document:

1. The information included in this document reflects representative usage scenarios and is intended for technical reference only.
2. The part number, type, and specifications mentioned in this document are subject to future change and improvement without notice. Before production usage customer should refer to the latest datasheet for the updated specifications.
3. When using the products referenced in this document, please make sure the product is being operated within the environmental and electrical limits specified in the datasheet. If customer usage exceeds the specified limits, LuckyLight will not be responsible for any subsequent issues.
4. The information in this document applies to typical usage in consumer electronics applications. If customer's application has special reliability requirements or have life-threatening liabilities, such as automotive or medical usage, please consult with LuckyLight representative for further assistance.
5. The contents and information of this document may not be reproduced or re-transmitted without permission by LuckyLight.

---

Spec No.: R3014

Issue No.: G-Rev-5

LuckyLight Electronics Co., Ltd

Copyright © 2020 LuckyLight All Rights Reserved

Date: 12-Sep-2020

E-mail: [sales@luckylight.cn](mailto:sales@luckylight.cn)

[http:// www.luckylight.cn](http://www.luckylight.cn)

Page: 11 / 11