

## R1515RGBM-008-B

1.5x1.5mm, Common Anode Multi-color LED

Surface Mount PLCC-4 LED Indicator

**LuckyLight**

## Technical Data Sheet

---

### Features:

- PLCC-4 package.
- White package.
- Optical indicator.
- White Diffused
- Black face.
- Ideal for backlight and light pipe application.
- Wide viewing angle.
- Suitable for automatic placement equipment.
- Available on tape and reel (8mm Tape).
- The product itself will remain within RoHS compliant Version.

### Descriptions:

- The R1515 series is available in soft red, orange, yellow, green, blue and white. Due to the package design, the LED has wide viewing angle and optimized light coupling by inter reflector. This feature makes the SMT TOP LED ideal for light pipe application. The low current requirement makes this device ideal for portable equipment or any other application where power is at a premium.

### Applications:

- Backlight in dashboards and switches.
- Telecommunication: Indicator and backlight in telephone and fax.
- Indicator and backlight for audio and video equipment.
- Indicator and backlight in office and family equipment.
- Flat backlight for LCD's, switches and symbols.
- Light pipe application.
- General use.

# R1515RGBM-008-B

1.5x1.5mm, Common Anode Multi-color LED

Surface Mount PLCC-4 LED Indicator



## Technical Data Sheet

Part No.	Emitting Color	Lens Color
R1515RGBM-008-B	R Red	White Diffused
	G Pure Green	
	B Blue	

### Package Dimension:

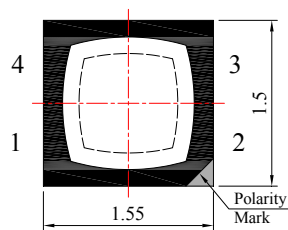

Top View

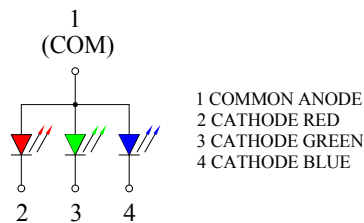

Polarity

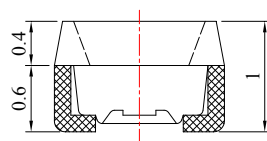

Side View

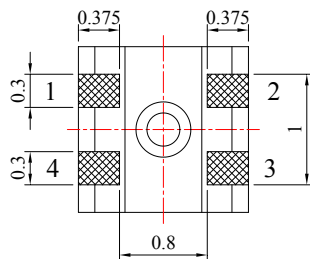

Bottom View

### Recommended Soldering Pad Dimensions

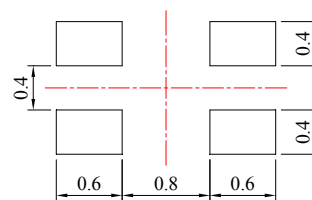

Unit: mm  
Tolerance:  $\pm 0.10\text{mm}$

### Notes:

1. All dimensions are in millimeters (inches).
2. Tolerance is  $\pm 0.25\text{ mm}$  (.010") unless otherwise noted.
3. Protruded resin under flange is 1.00mm (.039") max.

## R1515RGBM-008-B

1.5x1.5mm, Common Anode Multi-color LED  
Surface Mount PLCC-4 LED Indicator



## Technical Data Sheet

### Absolute Maximum Ratings at Ta=25°C

Parameters		Symbol	Max.	Unit
Power Dissipation	R	PD	48	mW
	G			
	B			
Peak Forward Current (Per Chip) <sup>(a)</sup>		IFP	100	mA
Forward Current (Per Chip) <sup>(b)</sup>	R	IF	20	mA
	G			
	B			
Reverse Voltage (Per Chip)		VR	5	V
Electrostatic Discharge (HBM)	R	ESD	2000	V
	G			
	B			
Operating Temperature Range		Topr	-40°C to +85°C	
Storage Temperature Range		Tstg	-40°C to +100°C	
Lead Soldering Temperature [4mm (.157") From Body]		Tsld	250°C for 5 Seconds	

#### Notes:

- Derate linearly as shown in derating curve.
- Duty Factor = 10%, Frequency = 1 kHz.

# R1515RGBM-008-B

1.5x1.5mm, Common Anode Multi-color LED

Surface Mount PLCC-4 LED Indicator



## Technical Data Sheet

### Electrical Optical Characteristics at Ta=25°C

Parameters	Symbol	Emitting Color	Min.	Typ.	Max.	Unit	Test Condition
Luminous Intensity <sup>(a)</sup>	IV	R	30	50	---	mcd	IF=8mA
		G	95	160	---		IF=5mA
		B	10	20	---		IF=3mA
Viewing Angle <sup>(b)</sup>	2θ <sub>1/2</sub>	R	---	120	---	Deg	IF=8mA
		G	---	120	---		IF=5mA
		B	---	120	---		IF=3mA
Peak Emission Wavelength	λ <sub>p</sub>	R	---	632	---	nm	IF=8mA
		G	---	520	---		IF=5mA
		B	---	468	---		IF=3mA
Dominant Wavelength <sup>(c)</sup>	λ <sub>d</sub>	R	---	624	---	nm	IF=8mA
		G	---	525	---		IF=5mA
		B	---	470	---		IF=3mA
Spectral Line Half-Width	Δλ	R	---	20	---	nm	IF=8mA
		G	---	35	---		IF=5mA
		B	---	25	---		IF=3mA
Forward Voltage	VF	R	1.60	2.00	2.40	V	IF=8mA
		G	2.40	2.60	3.20		IF=5mA
		B	2.40	2.60	3.20		IF=3mA
Reverse Current	IR	R	---	---	10	μA	V <sub>R</sub> =5V
		G					
		B					

#### Notes:

- Luminous intensity is measured with a light sensor and filter combination that approximates the CIE eye-response curve.
- 2θ<sub>1/2</sub> is the o-axis angle where the luminous intensity is 1/2 the peak intensity.
- The dominant wavelength (λ<sub>d</sub>) is derived from the CIE chromaticity diagram and represents the single wavelength which defines the color of the device.

# R1515RGBM-008-B

1.5x1.5mm, Common Anode Multi-color LED

Surface Mount PLCC-4 LED Indicator



## Technical Data Sheet

### Typical Electrical / Optical Characteristics Curves (25°C Ambient Temperature Unless Otherwise Noted)

Red:

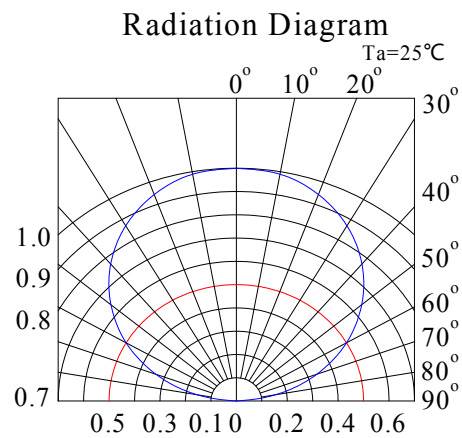
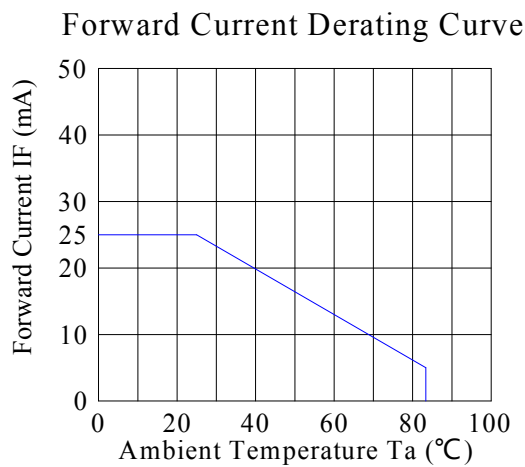
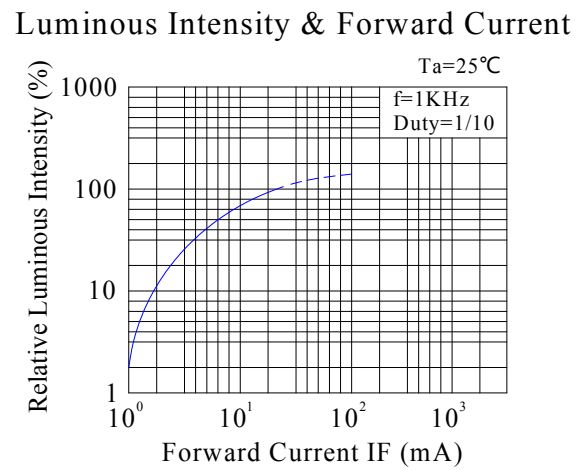
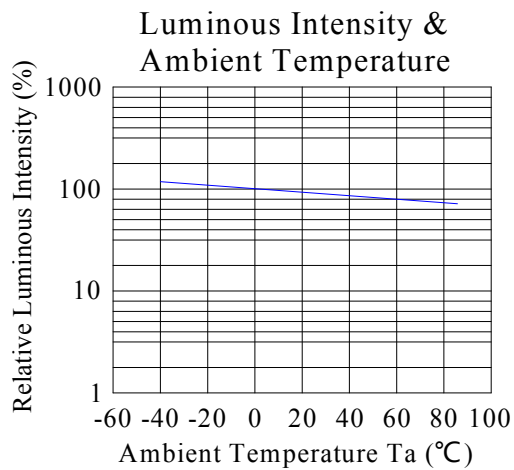
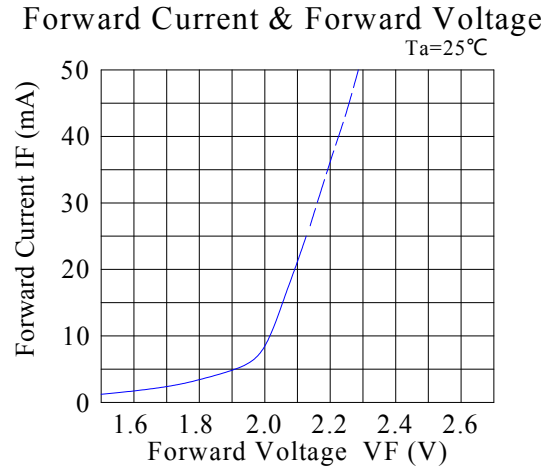
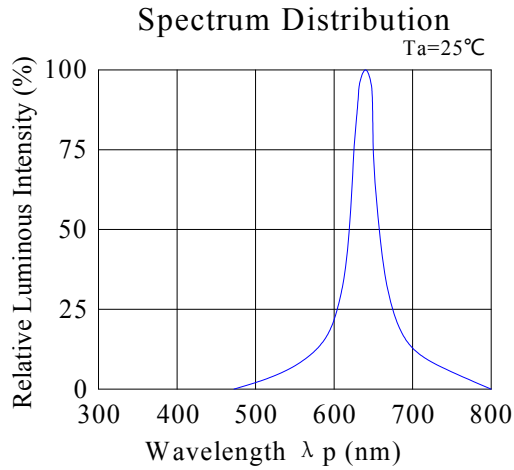

# R1515RGBM-008-B

1.5x1.5mm, Common Anode Multi-color LED

Surface Mount PLCC-4 LED Indicator



## Technical Data Sheet

Green:

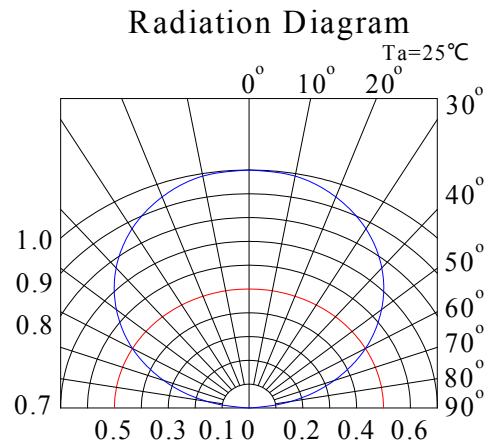
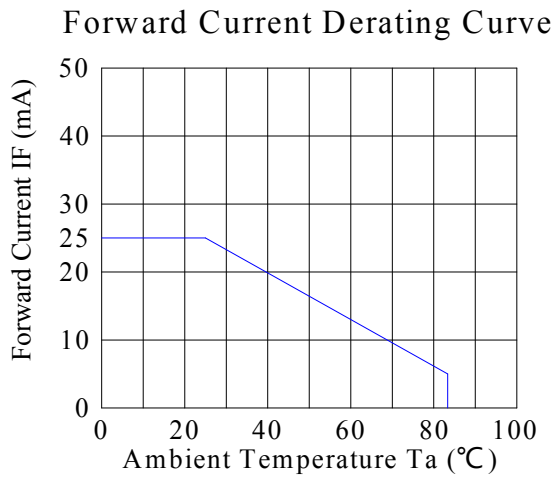
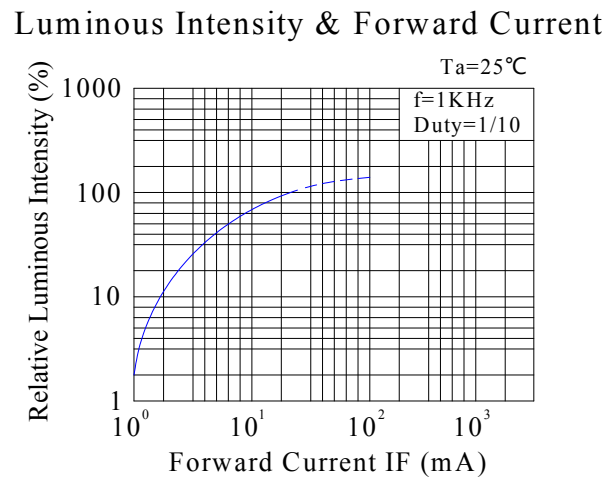
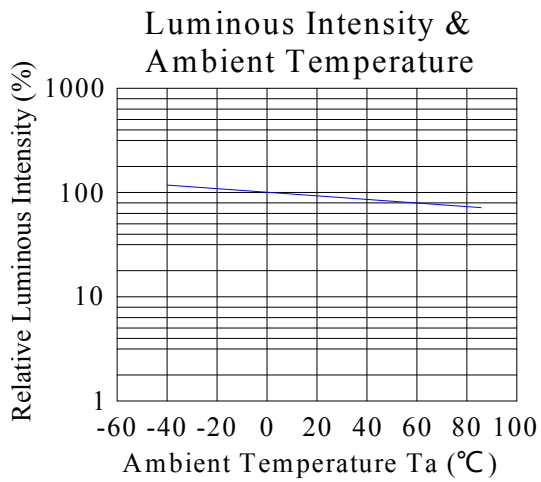
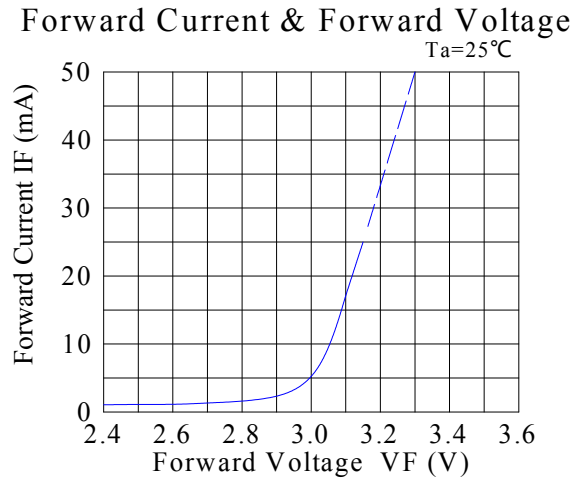
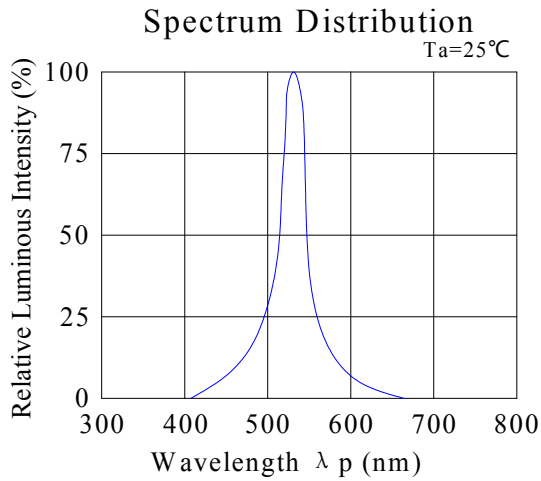

# R1515RGBM-008-B

1.5x1.5mm, Common Anode Multi-color LED

Surface Mount PLCC-4 LED Indicator



## Technical Data Sheet

Blue:

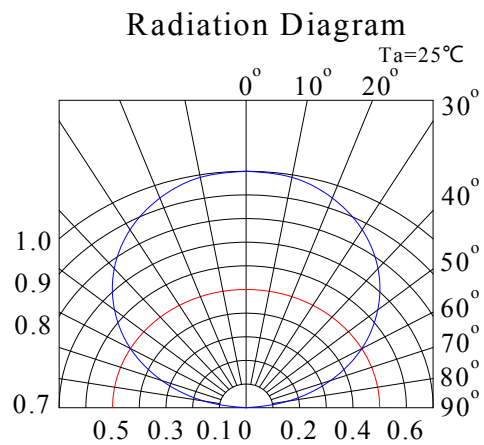
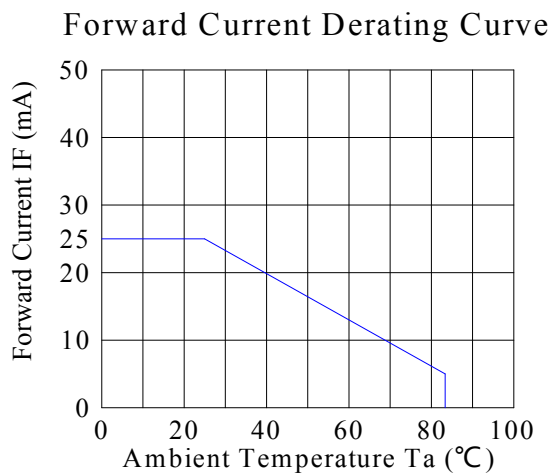
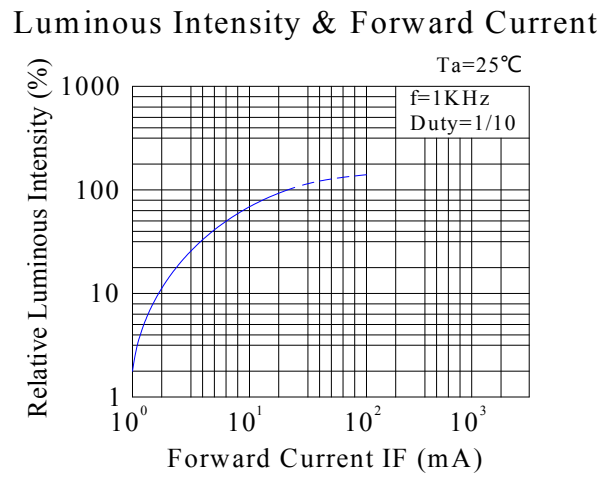
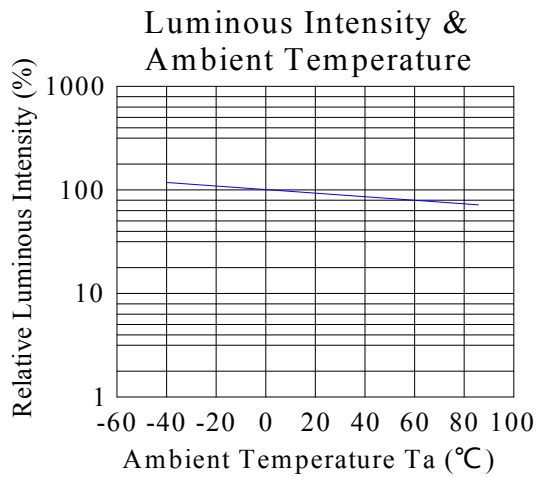
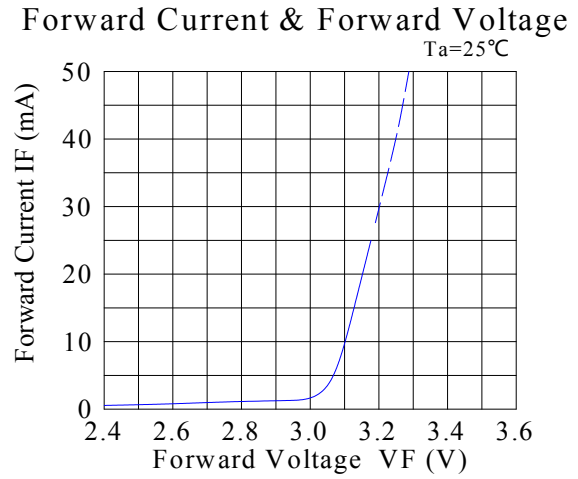
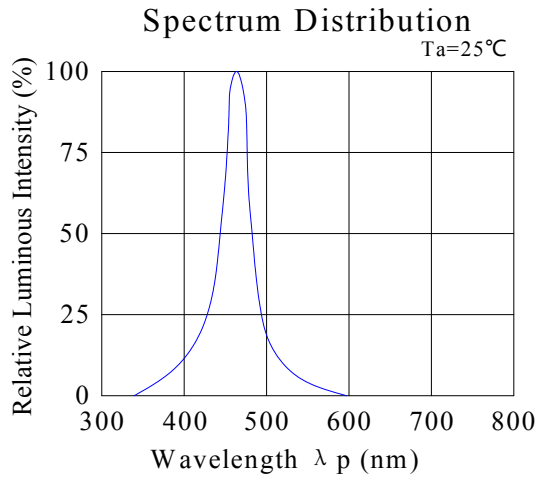

## R1515RGBM-008-B

1.5x1.5mm, Common Anode Multi-color LED

Surface Mount PLCC-4 LED Indicator

LuckyLight

## Technical Data Sheet

### Reel Dimensions:

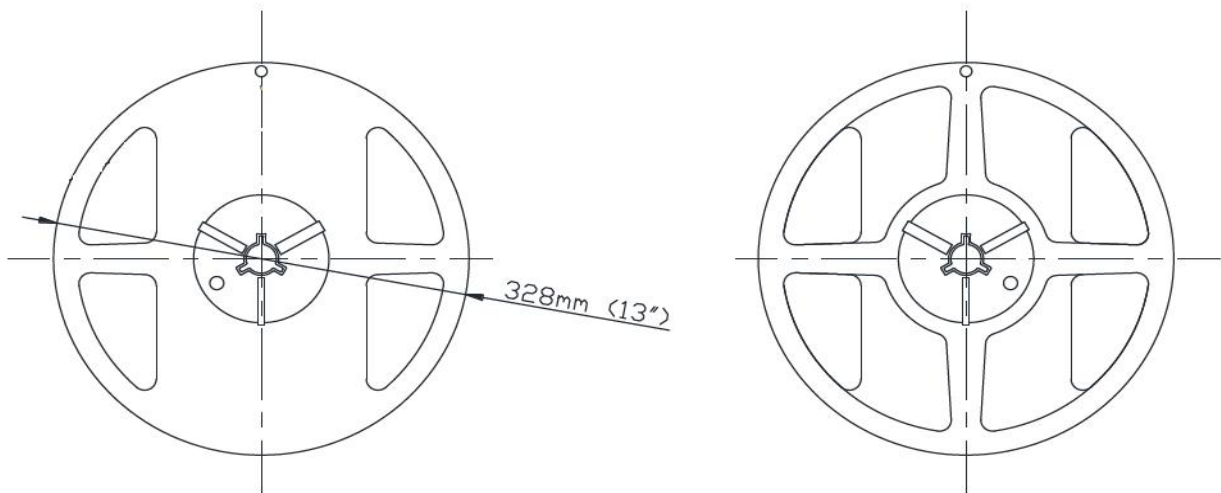

### Carrier Tape Dimensions:

Loaded quantity 14000 pcs per reel.

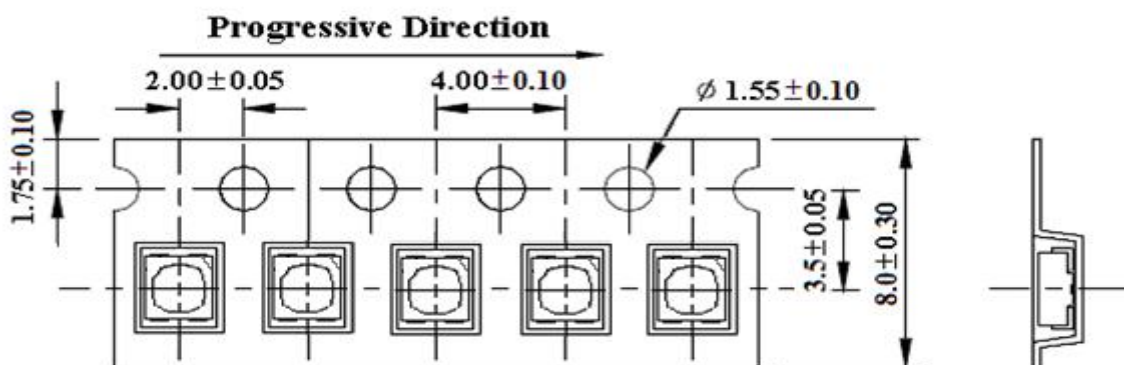

Unit: mm  
Tolerance:  $\pm 0.10$  mm

Spec No.: R1515

Issue No.: G-Rev-4

LuckyLight Electronics Co., Ltd

Copyright © 2017 LuckyLight All Rights Reserved

Date: 28-Mar-2017

E-mail: sales@luckyLight.cn

http:// www.luckyLight.cn

Page: 8 / 12



## R1515RGBM-008-B

1.5x1.5mm, Common Anode Multi-color LED

Surface Mount PLCC-4 LED Indicator

LuckyLight

## Technical Data Sheet

---

### CAUTIONS

#### 1. Handling Precautions:

- 1.1. Handle the component along the side surfaces by using forceps or appropriate tools.
- 1.2. Do not directly touch or handle the silicone lens surface. It may damage the internal circuitry.
- 1.3. Do not stack together assembled PCBs containing exposed LEDs. Impact may scratch the silicone lens or damage the internal circuitry.

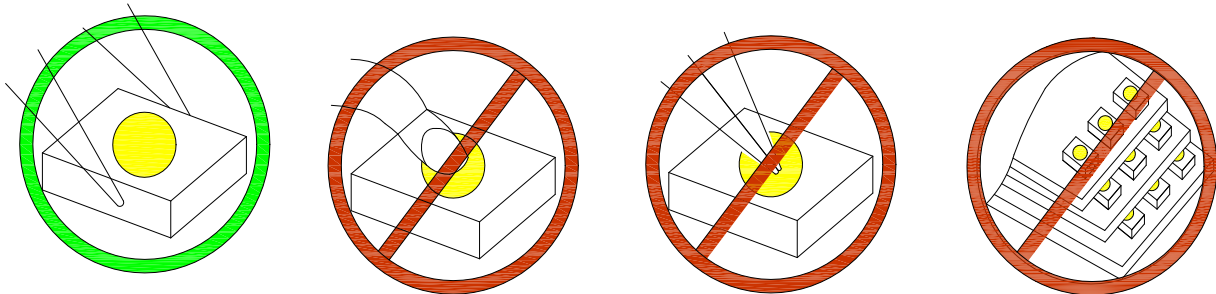

Compare to epoxy encapsulant that is hard and brittle, silicone is softer and flexible. Although its characteristic significantly reduces thermal stress, it is more susceptible to damage by external mechanical force. As a result, special handling precautions need to be observed during assembly using silicone encapsulated LED products. Failure to comply might lead to damage and premature failure of the LED.

#### 2. Storage

- 2.1. Do not open moisture proof bag before the products are ready to use.
- 2.2. Before opening the package, the LEDs should be kept at 30°C or less and 60%RH or less.
- 2.3. The LEDs should be used within a year.
- 2.4. After opening the package, the LEDs should be kept at 30°C or less and 60%RH or less.
- 2.5. The LEDs should be used within 24 hours after opening the package.
- 2.6. If the moisture adsorbent material has fabled away or the LEDs have exceeded the storage time, baking treatment should be performed using the following conditions. Baking treatment: 65±5°C for 24 hours.

#### 3. Soldering Condition

---

Spec No.: R1515

Issue No.: G-Rev-4

LuckyLight Electronics Co., Ltd

Copyright © 2017 LuckyLight All Rights Reserved

Date: 28-Mar-2017

E-mail: sales@luckylight.cn

http:// www.luckylight.cn

Page: 9 / 12

# R1515RGBM-008-B

1.5x1.5mm, Common Anode Multi-color LED

Surface Mount PLCC-4 LED Indicator



## Technical Data Sheet

### 3.1. Pb-free solder temperature profile

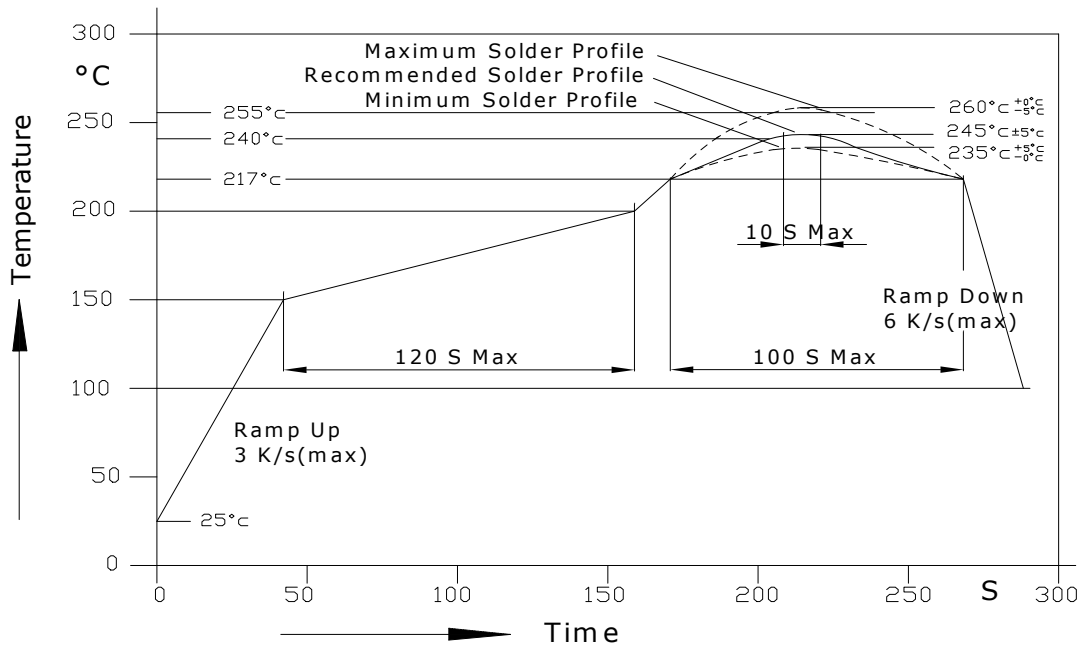

3.2. Reflow soldering should not be done more than two times.

3.3. When soldering, do not put stress on the LEDs during heating.

3.4. After soldering, do not warp the circuit board.

3.5. Recommended soldering conditions:

Reflow soldering		Soldering iron	
Pre-heat	150~200°C	Temperature	300°C Max.
Pre-heat time	120 sec. Max.	Soldering time	3 sec. Max.
Peak temperature	250°C Max.		(one time only)
Soldering time	10 sec. Max.(Max. two times)		

3.6. Because different board designs use different number and types of devices, solder pastes, reflow ovens, and circuit boards, no single temperature profile works for all possible combinations.

However, you can successfully mount your packages to the PCB by following the proper guidelines and PCB-specific

## R1515RGBM-008-B

1.5x1.5mm, Common Anode Multi-color LED

Surface Mount PLCC-4 LED Indicator

LuckyLight

## Technical Data Sheet

---

characterization.

### 4. Drive Method

4.1. An LED is a current-operated device. In order to ensure intensity uniformity on multiple LEDs connected in parallel in an application, it is recommended that a current limiting resistor be incorporated in the drive circuit, in series with each LED as shown in Circuit A below.

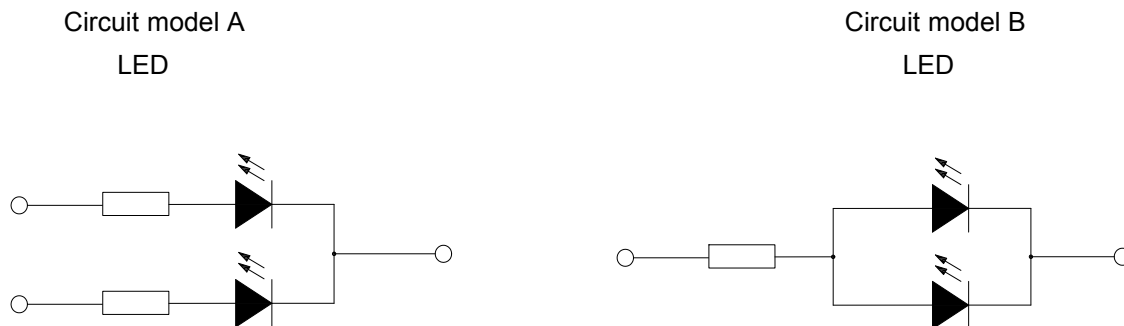

- Recommended circuit.
- The brightness of each LED might appear different due to the differences in the I-V characteristics of those LEDs.

### 5. ESD (Electrostatic Discharge):

Static Electricity or power surge will damage the LED. Suggestions to prevent ESD damage:

- Use of a conductive wrist band or anti-electrostatic glove when handling these LEDs.
- All devices, equipment, and machinery must be properly grounded.
- Work tables, storage racks, etc. should be properly grounded.
- Use ion blower to neutralize the static charge which might have built up on surface of the LED's plastic lens as a result of friction between LEDs during storage and handling.

ESD-damaged LEDs will exhibit abnormal characteristics such as high reverse leakage current, low forward voltage, or “no lightup” at low currents. To verify for ESD damage, check for “lightup” and  $V_f$  of the suspect LEDs at low currents. The  $V_f$  of “good” LEDs should be  $>2.0V@0.1mA$  for InGaN product and  $>1.4V@0.1mA$  for AlInGaP product.

## R1515RGBM-008-B

1.5x1.5mm, Common Anode Multi-color LED

Surface Mount PLCC-4 LED Indicator



## Technical Data Sheet

---

### Terms and conditions for the usage of this document

1. The information included in this document reflects representative usage scenarios and is intended for technical reference only.
2. The part number, type, and specifications mentioned in this document are subject to future change and improvement without notice. Before production usage customer should refer to the latest datasheet for the updated specifications.
3. When using the products referenced in this document, please make sure the product is being operated within the environmental and electrical limits specified in the datasheet. If customer usage exceeds the specified limits, LuckyLight will not be responsible for any subsequent issues.
4. The information in this document applies to typical usage in consumer electronics applications. If customer's application has special reliability requirements or have life-threatening liabilities, such as automotive or medical usage, please consult with LuckyLight representative for further assistance.
5. The contents and information of this document may not be reproduced or re-transmitted without permission by LuckyLight.