

PB1414WX-5W

13.5x13.5mm, 5w White LED

High power Surface Light Source COB

Technical Data Sheet

Features:

- High power COB LED type.
- Optical indicator.
- The light is soft and natural.
- Good agreement.
- Ideal for Illumination application.
- Wide viewing angle.
- Very long operating life.
- Instant light (less than 100ns).
- Designed for high current operation.
- Low thermal resistance.
- The product itself will remain within RoHS compliant Version.

Applications:

- For a variety of lighting.
- Indoor/Outdoor Commercial and Residential Architectural.

Device Selection Guide:

Part No.	Emitting Color
PB1414W2-5W	Cool White
PB1414W5-5W	Neutral White
PB1414W6-5W	Warm White

PB1414WX-5W

13.5x13.5mm, 5w White LED
High power Surface Light Source COB

Technical Data Sheet

Package Dimension:

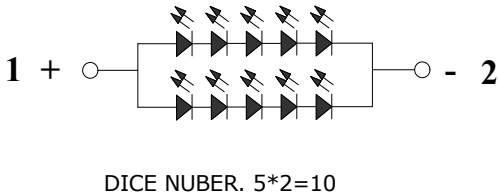
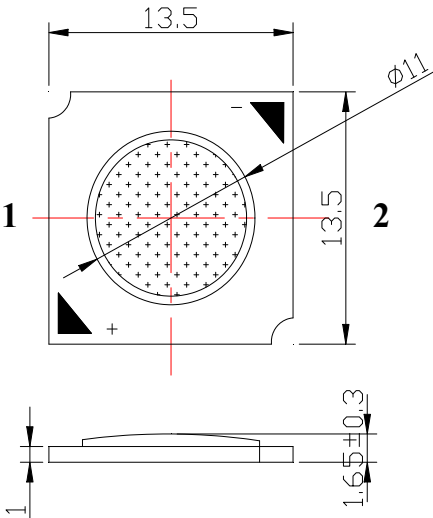

Polarity

Notes:

- 1. All dimensions are in millimeters (inches).
- 2. Tolerance is ± 0.25 mm (.010") unless otherwise noted.

PB1414WX-5W

13.5x13.5mm, 5w White LED

High power Surface Light Source COB

Technical Data Sheet

Absolute Maximum Ratings at Ta=25°C

Parameters	Symbol	Max	Unit
Power Dissipation	Pd	5	W
Peak Forward Current ^(a)	IFP	350	mA
DC Forward Current	IF	320	mA
Reverse Voltage	VR	5	V
LED Junction Temperature	Tj	120	°C
Operating Temperature Range	Topr	-20°C to +85°C	
Storage Temperature Range	Tstg	-30°C to +85°C	

Note:

a. Pulse width ≤ 0.1ms, Duty ≤ 1/10

Electrical Optical Characteristics at Ta=25°C

Parameters	Symbol	Emitting Color	Min.	Typ.	Max.	Unit	Test Condition
Luminous Flux ^(a)	Φv	W2	500	600	---	Lm	IF=320mA
		W5	500	600	---		
		W6	500	550	---		
Viewing Angle	2θ1/2		---	120	---	Deg	IF=320mA
Chromaticity Coordinates ^(b)	x	W2	---	0.32	---		IF=320mA
		W5	---	0.37	---		
		W6	---	0.43	---		

PB1414WX-5W

13.5x13.5mm, 5w White LED

High power Surface Light Source COB

Technical Data Sheet

		W2	---	0.33	---		
	y	W5	---	0.37	---		
		W6	---	0.40	---		
Color Temperature	CCT	W2	5000	6500	---	K	IF=320mA
		W5	3800	4500	5500		
		W6	2600	3000	3800		
Color Rendering Index	CRI	W2	80	---	---	Ra	IF=320mA
		W5	80	---	---		
		W6	80	---	---		
Forward Voltage ^(C)	VF	W2	14.5	16.5	19	V	IF=320mA
		W5	14.5	16.5	19		
		W6	14.5	16.5	19		
Reverse Current	IR	W2	---	---	10	μA	V _R =5V
		W5	---	---	10		
		W6	---	---	10		

Notes:

- a. Luminous flux measurement tolerance: ±10%.
- b. Color coordinates measurement tolerance: ±0.015
- c. Forward voltage measurement tolerance: ±0.1V

PB1414WX-5W

13.5x13.5mm, 5w White LED

High power Surface Light Source COB



Technical Data Sheet

Typical Electrical / Optical Characteristics Curves (25°C Ambient Temperature Unless Otherwise Noted)

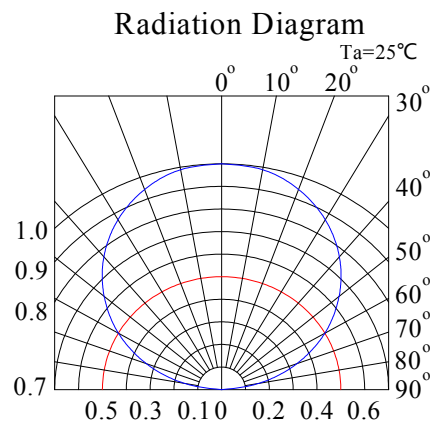
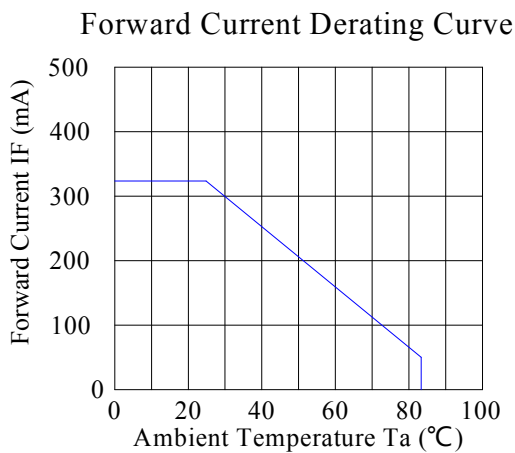
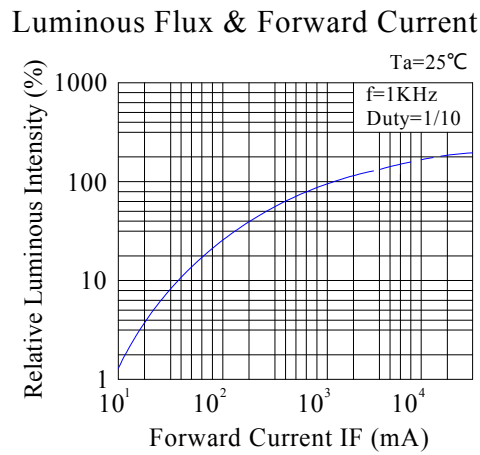
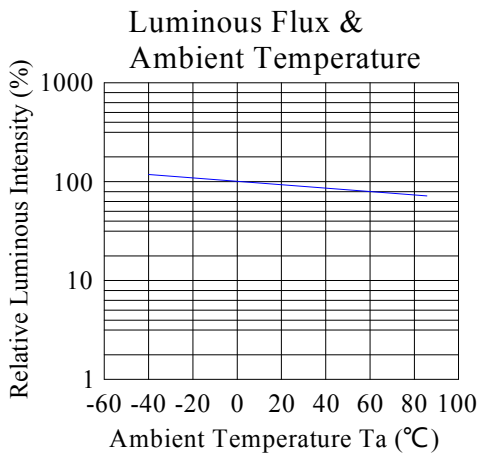
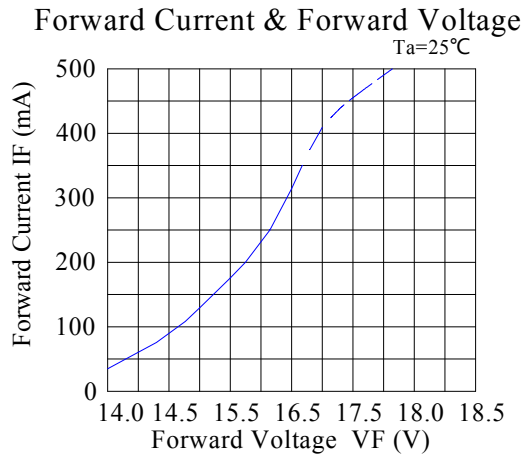
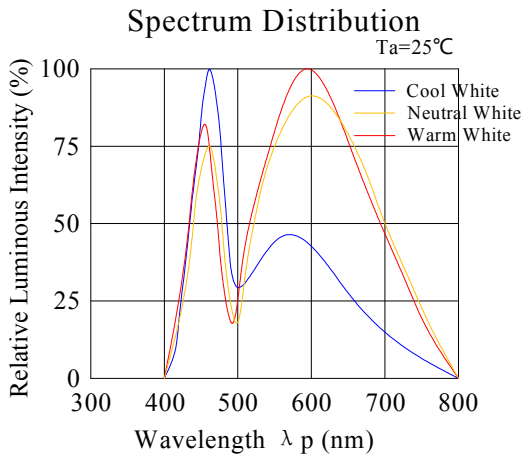

PB1414WX-5W

13.5x13.5mm, 5w White LED

High power Surface Light Source COB

Technical Data Sheet

CIE 1931 Chromaticity Diagram:

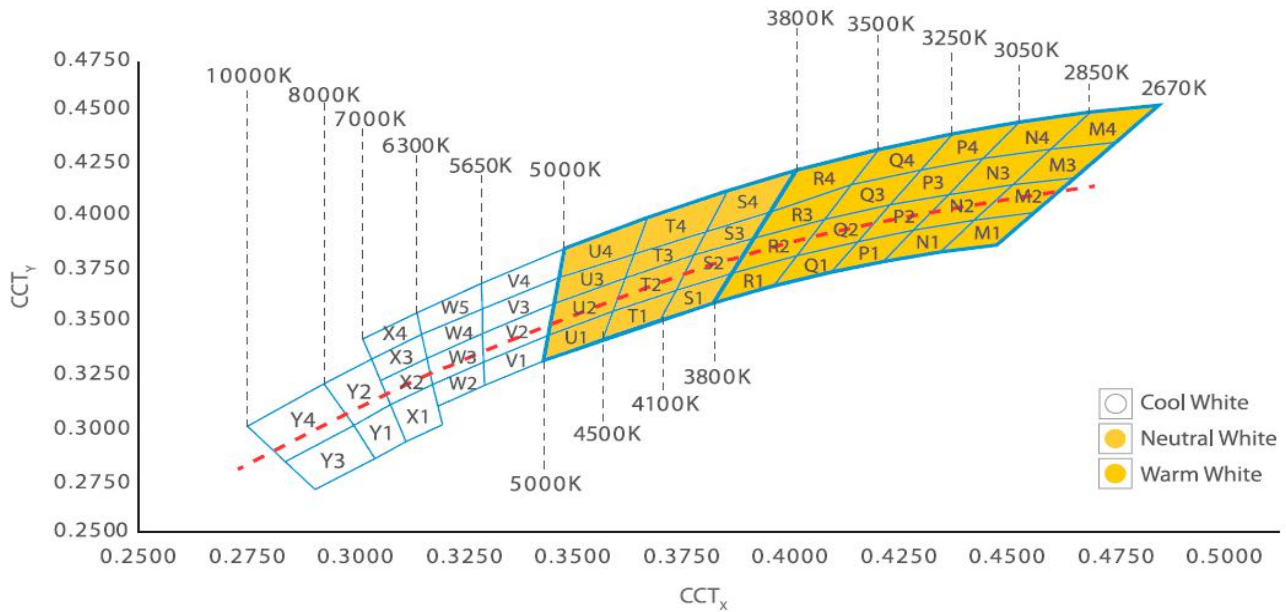

Chromaticity Coordinates Specifications for Bin Rank:

Group/ CCT (Typ.)	X	Y	Group/ CCT (Typ.)	X	Y	Group/ CCT (Typ.)	X	Y	Group/ CCT (Typ.)	X	Y
M1	0.4436	0.3991	N1	0.4293	0.3942	P1	0.4293	0.3942	Q1	0.4164	0.3890
2,700K	0.4576	0.4028	2,900K	0.4436	0.3991	3,150K	0.4221	0.3789	3,300K	0.4021	0.3821
	0.4489	0.3875		0.4355	0.3837		0.4100	0.3738		0.4100	0.3738
	0.4355	0.3837		0.4221	0.3789		0.4164	0.3890		0.3965	0.3672
M2	0.4525	0.4162	N2	0.4375	0.4116	P2	0.4239	0.4064	Q2	0.4085	0.3995
2,700K	0.4671	0.4196	2,900K	0.4293	0.3942	3,150K	0.4375	0.4116	3,300K	0.4239	0.4064
	0.4576	0.4028		0.4436	0.3991		0.4293	0.3942		0.4164	0.3890
	0.4436	0.3991		0.4525	0.4162		0.4164	0.3890		0.4021	0.3821
M3	0.4614	0.4333	N3	0.4614	0.4333	P3	0.4311	0.4233	Q3	0.4085	0.3995
2,700K	0.4767	0.4366	2,900K	0.4525	0.4162	3,150K	0.4456	0.4286	3,300K	0.4147	0.4161
	0.4671	0.4196		0.4375	0.4116		0.4375	0.4116		0.4311	0.4233
	0.4525	0.4162		0.4456	0.4286		0.4239	0.4064		0.4239	0.4064
M4	0.4705	0.4508	N4	0.4538	0.4459	P4	0.4384	0.4404	Q4	0.4384	0.4404
2,700K	0.4866	0.4541	2,900K	0.4705	0.4508	3,150K	0.4538	0.4459	3,300K	0.4311	0.4233
	0.4767	0.4366		0.4614	0.4333		0.4456	0.4286		0.4147	0.4161
	0.4614	0.4333		0.4456	0.4286		0.4311	0.4233		0.4209	0.4326

PB1414WX-5W

13.5x13.5mm, 5w White LED

High power Surface Light Source COB



Technical Data Sheet

Group/ CCT (Typ.)	X	Y	Group/ CCT (Typ.)	X	Y	Group/ CCT (Typ.)	X	Y	Group/ CCT (Typ.)	X	Y
R1 3,650K	0.3870	0.3739	T1 4,300K	0.3594	0.3556	V1 5,300K	0.3292	0.3313	X1 6,650K	0.3075	0.3107
	0.4021	0.3821		0.3570	0.3425		0.3444	0.3442		0.3174	0.3204
	0.3965	0.3672		0.3705	0.3519		0.3433	0.3320		0.3196	0.3013
	0.3826	0.3595		0.3740	0.3658		0.3293	0.3200		0.3111	0.2931
R2 3,650K	0.3923	0.3909	T2 4,300K	0.3622	0.3716	V2 5,300K	0.3292	0.3313	X2 6,650K	0.3075	0.3107
	0.3870	0.3739		0.3782	0.3824		0.3290	0.3450		0.3051	0.3223
	0.4021	0.3821		0.3740	0.3658		0.3457	0.3591		0.3160	0.3332
	0.40859	0.3995		0.3594	0.3556		0.3444	0.3442		0.3174	0.3204
R3 3,650K	0.40859	0.3995	T3 4,300K	0.3642	0.3828	V3 5,300K	0.3290	0.3450	X3 6,650K	0.3051	0.3223
	0.39237	0.3909		0.3811	0.3937		0.3288	0.3569		0.3030	0.3327
	0.39628	0.4035		0.3782	0.3824		0.3469	0.3717		0.3147	0.3444
	0.41478	0.4161		0.3622	0.3716		0.3457	0.3591		0.3160	0.3332
R4 3,650K	0.40227	0.4227	T4 4,300K	0.3672	0.4002	V4 5,300K	0.3288	0.3569	X4 6,650K	0.3030	0.3327
	0.42094	0.4326		0.3859	0.4129		0.3286	0.3689		0.3010	0.3422
	0.41478	0.4161		0.3811	0.3937		0.3481	0.3856		0.3136	0.3549
	0.39628	0.4035		0.3642	0.3828		0.3469	0.3717		0.3147	0.3444
S1 3,900K	0.3470	0.3658	U1 4,750K	0.3444	0.3442	W2 6,000K	0.3292	0.3313	Y1 7,500K	0.3040	0.2850
	0.3870	0.3738		0.3433	0.3320		0.3293	0.3202		0.2990	0.3010
	0.3825	0.3595		0.3570	0.3425		0.3186	0.3102		0.3075	0.3107
	0.3705	0.3519		0.3594	0.3556		0.3174	0.3204		0.3111	0.2931
S2 3,900K	0.3782	0.3824	U2 4,750K	0.3622	0.3716	W3 6,000K	0.3290	0.3450	Y2 7,500K	0.2990	0.3010
	0.3923	0.3909		0.3594	0.3556		0.3292	0.3313		0.2920	0.3210
	0.3870	0.3738		0.3444	0.3442		0.3174	0.3204		0.3030	0.3327
	0.3740	0.3658		0.3457	0.3591		0.3160	0.3332		0.3075	0.3107
S3 3,900K	0.3782	0.3824	U3 4,750K	0.3642	0.3828	W4 6,000K	0.3290	0.3450	Y3 9,000K	0.3040	0.2850
	0.3811	0.3937		0.3622	0.3716		0.3160	0.3332		0.2899	0.2703
	0.3962	0.4035		0.3457	0.3591		0.3147	0.3444		0.2829	0.2837
	0.3923	0.3909		0.3469	0.3717		0.3288	0.3569		0.2990	0.3010
S4 3,900K	0.3859	0.4129	U4 4,750K	0.3642	0.3828	W5 6,000K	0.3147	0.3444	Y4 9,000K	0.2920	0.3210
	0.4022	0.4227		0.3672	0.4002		0.3136	0.3549		0.2742	0.3006
	0.3962	0.4035		0.3481	0.3856		0.3186	0.3689		0.2829	0.2837
	0.3811	0.3937		0.3469	0.3717		0.3288	0.3569		0.2990	0.3010

Notes:

1. Color coordinates measurement allowance is ± 0.015 .
2. One delivery will include up to two consecutive color ranks and three luminous intensity ranks of the products the quantity-ratio of the ranks is decided by **LuckyLight**.

PB1414WX-5W

13.5x13.5mm, 5w White LED

High power Surface Light Source COB

Technical Data Sheet

CAUTIONS

Please read the following notes before using the product:

The LED's are devices which are materialized by combining blue LED's and special phosphors. Consequently the color of the LED's is changed a little by an operating current. Care should be taken after due consideration when using LED's.

(1) Moisture Proof Package:

When moisture is absorbed into package it may vaporize and expand during soldering. There is a possibility that this can cause exfoliation of the contacts and damage to the optical characteristics of the LED's. For this reason, the moisture proof package is used to keep moisture to a minimum in the package.

(2) Storage Conditions

Before opening the package:

The LED's should be kept at 30°C or less and 60%RH or less. The LED's should be used within a year. When storing the LED's. Moisture proof packaging with absorbent material (silica gel) is recommended.

After opening the package:

The LED's should be kept at 30°C or less and 50%RH or less. The LED's should be soldered within 168 hours (7days) after opening the package. If unused LED's remain, they should be stored in moisture proof packages, such as sealed containers with packages of moisture absorbent material (silica gel). It is also recommended to return the LED's to the original moisture proof bag and to reseal the moisture proof bag again. If the moisture absorbent material (silica gel) has faded away or the LED's have exceeded the storage time, baking treatment should be performed using the following conditions. Baking treatment: more than 48 hours at 65±5°C
LEDGUHON LED electrode and lead free are comprised of a silver plated copper alloy. The silver surface may be affected by environments which contain corrosive gases and so on. Please Avoid conditions which may cause the LED to corrode, tarnish or discolor. This corrosion or discoloration might lower solderability or might affect on optical characteristics. Please avoid rapid transitions in ambient temperature, especially in high humidity environments where condensation can occur.

(3) Heat Generation

Thermal design of the end product is of paramount importance. Please consider the heat generation of the LED when making the system design. The coefficient of temperature increase per input electric power is affected by the thermal resistance of the circuit board and density of LED placement on the board, as well as other components. It is necessary to avoid intense heat generation and operate within the maximum ratings given in this specification. The operating current should be decided after considering the ambient maximum temperature of LED's.

PB1414WX-5W

13.5x13.5mm, 5w White LED

High power Surface Light Source COB

Technical Data Sheet

(4) Cleaning

It is recommended that isopropyl alcohol be used as a solvent for cleaning the LED's. when using other solvents, it should be confirmed beforehand whether the solvents will dissolve the package and the resin or not. Freon solvents should not be used to clean the LED's because of worldwide regulations. Do not clean the LED's by the ultrasonic. When it is absolutely necessary, the influence of ultrasonic cleaning on the LED's depends on factors such as ultrasonic power and the assembled condition. Before cleaning, a pre-test should be done to confirm whether any damage to the LED's will occur °C

(5) Static Electricity

Static electricity or surge voltage damages the LED's. It is recommended that a wrist band or an anti-electrostatic glove be used when handling the LED's. All devices, equipment and machinery must be properly grounded. It is recommended that measures be taken against surge voltage to the equipment that mounts the LED's. When inspecting the final products in which LED's were assembled, it is recommended to check. Whether the assembled LED's are damaged by static electricity or not, it is easy to find static-damaged LED's by a light -on test or a VF test at a lower current (below 1mA is recommended). Damaged LED's will show some unusual characteristics such as the leak current remarkably increases, the forward voltage becomes lower, or the LED's do not light at the low current. Criteria ($V_f > 2.0V$ at $I_f = 0.5mA$)

(6) Others

Care must be taken to ensure that the reverse voltage will not exceed the absolute maximum rating when using the LED's with matrix drive. The LED light output is strong enough to injure human eyes. Precautions must be taken to prevent looking directly at the LED's with unaided eyes for more than a few seconds. Flashing lights have been known to cause discomfort in people, you can prevent this by taking precautions during use. Also, people should be cautions when using equipment that has had LED's incorporated into it. The LED's described in this brochure are intended to be used for ordinary electronic equipment (such as office equipment , communications equipment, measurement instruments and household appliances) Consult LEDGUHON's sales staff in advance for information on the applications in which exceptional quality and reliability are required, particularly when the failure or malfunction of the LED's may directly jeopardize life or health (such as for airplanes, aerospace, submersible repeaters, nuclear reactor control systems, automobile, traffic control equipment, life support systems and safety devices). User shall not reverse engineer by disassembling or analysis of the LED's without having prior written consent from LEDGUHON when defective LED's are found, the User shall inform LEDGUHONG directly before disassembling or analysis. The formal specifications must be exchanged and signed by both parties before large volume purchase begins. The appearance and specifications of the product may be modified for improvement without notice

PB1414WX-5W

13.5x13.5mm, 5w White LED

High power Surface Light Source COB

Technical Data Sheet



Terms and conditions for the usage of this document

1. The information included in this document reflects representative usage scenarios and is intended for technical reference only.
2. The part number, type, and specifications mentioned in this document are subject to future change and improvement without notice. Before production usage customer should refer to the latest datasheet for the updated specifications.
3. When using the products referenced in this document, please make sure the product is being operated within the environmental and electrical limits specified in the datasheet. If customer usage exceeds the specified limits, LuckyLight will not be responsible for any subsequent issues.
4. The information in this document applies to typical usage in consumer electronics applications. If customer's application has special reliability requirements or have life-threatening liabilities, such as automotive or medical usage, please consult with LuckyLight representative for further assistance.
5. The contents and information of this document may not be reproduced or re-transmitted without permission by LuckyLight.