

KW4-801ABB/KW4-801CBB

0.80 inch (20.40mm), Blue
Quadruple Digit 7-segment LED Display

Technical Data Sheet

Features:

- 0.80" (inch) digit height
- Low power consumption
- High reliability
- Excellent characters appearance
- Available in common cathode or common anode
- RoHS Compliant



Descriptions:

- The KW4-801ABB/KW4-801CBB is a 0.80 inch (20.40mm) height Quadruple digit display.
- The display provides excellent reliability in bright ambient light.
- The device is made with white segments and black surface.

Applications:

- Home appliances
- Instrument panels
- Digital readout displays
- Game console systems

Device Selection Guide:

Part No.	Emitting Color	Polarity
KW4-801ABB	Blue	Common Anode
KW4-801CBB	Blue	Common Cathode

KW4-801ABB/KW4-801CBB



0.80 inch (20.40mm), Blue

Quadruple Digit 7-segment LED Display

Technical Data Sheet

Package Dimension:

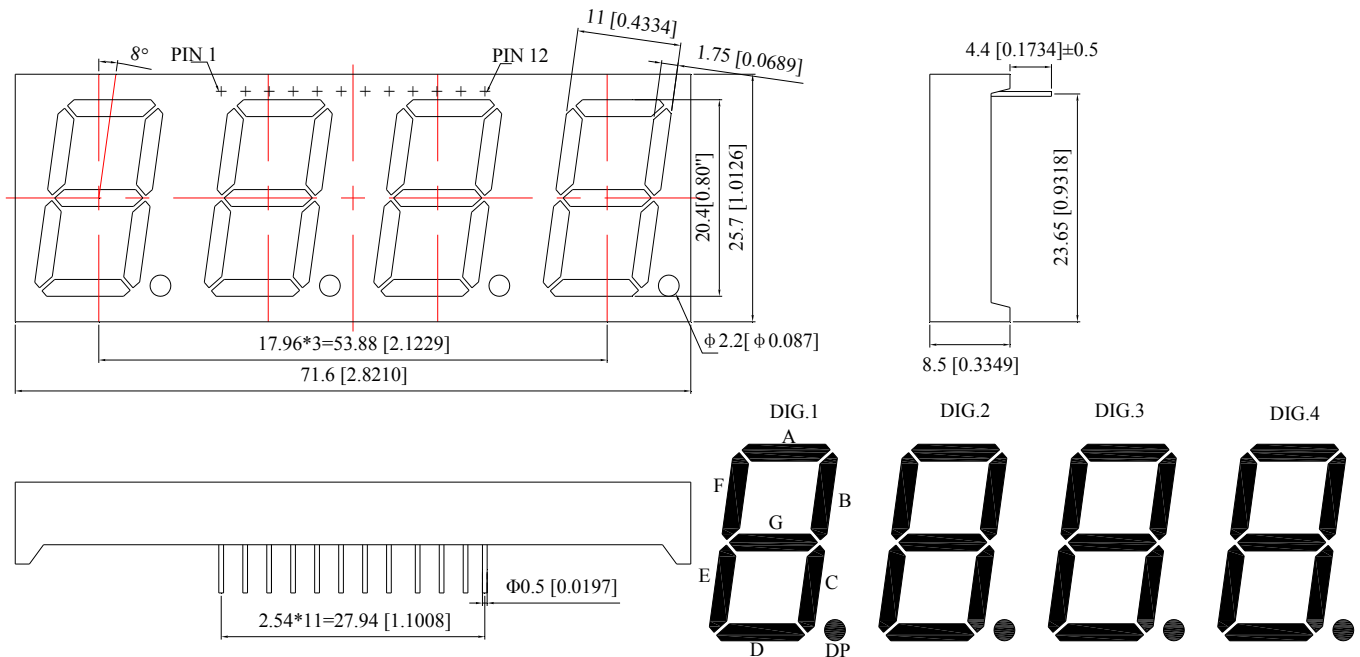

Notes:

1. All dimensions are in millimeters (inches).
2. Tolerance is ± 0.25 mm (.010") unless otherwise noted.

KW4-801ABB/KW4-801CBB



0.80 inch (20.40mm), Blue

Quadruple Digit 7-segment LED Display

Technical Data Sheet

Internal Circuit Diagram:

Internal Circuit Diagram (Common Anode)

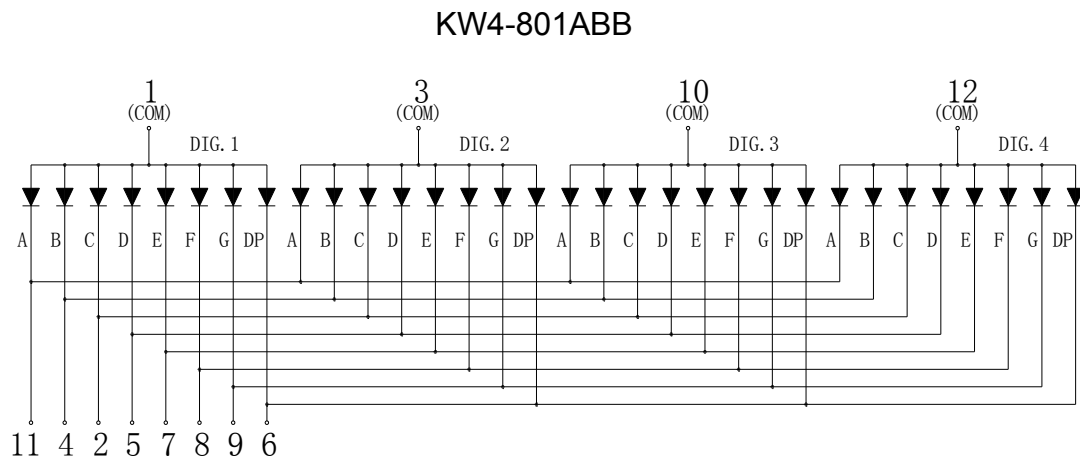

Internal Circuit Diagram (Common Cathode)

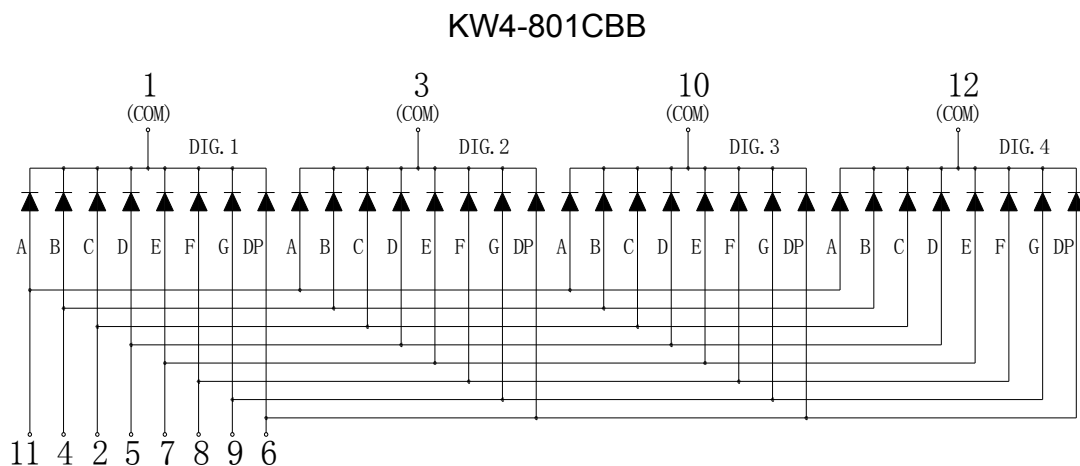

KW4-801ABB/KW4-801CBB



0.80 inch (20.40mm), Blue

Quadruple Digit 7-segment LED Display

Technical Data Sheet

Absolute Maximum Ratings at Ta=25°C

Parameters	Symbol	Max	Unit
Power Dissipation Per Segment	P_d	35	mW
Peak Forward Current Per Segment (1/10 Duty Cycle, 0.1ms Pulse Width)	I_{FP}	50	mA
Forward Current Per Segment	I_F	10	mA
Reverse Voltage Per Segment	V_R	5	V
Operating Temperature Range	T_{opr}	-40°C to +80°C	
Storage Temperature Range	T_{stg}	-40°C to +85°C	
Soldering Temperature	T_{sld}	260°C for 5 Seconds	

Electrical Optical Characteristics at Ta=25°C

Parameters	Symbol	Min.	Typ.	Max.	Unit	Test Condition
Average Luminous Intensity	I_v	14.0	28.0	---	mcd	IF=10mA (Note a)
Luminous Intensity Matching Ratio	I_{v-m}	---	---	2:1		IF=10mA
Peak Emission Wavelength	λ_p	---	468	---	nm	IF=10mA
Dominant Wavelength	λ_d	---	470	---	nm	IF=10mA (Note b)
Spectral Line Half-Width	$\Delta\lambda$	---	20	---	nm	IF=10mA
Forward Voltage Per Segment	V_F	---	2.9	3.1	V	IF=10mA
Reverse Current Per Segment	I_R	---	---	50	μA	VR=5V

Notes:

- Luminous intensity is measured with a light sensor and filter combination that approximates the CIE eye-response curve.
- The dominant wavelength (λ_d) is derived from the CIE chromaticity diagram and represents the single wavelength which defines the color of the device.

Technical Data Sheet

**Typical Electrical / Optical Characteristics Curves
(25°C Ambient Temperature Unless Otherwise Noted)**

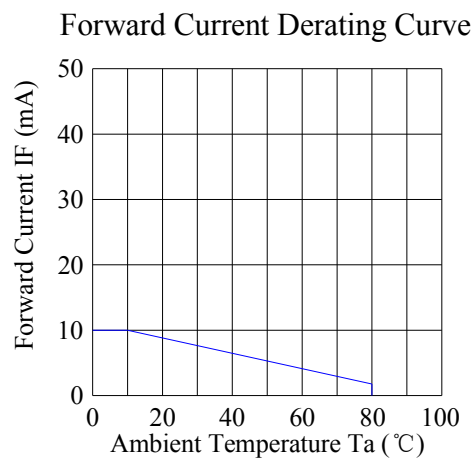
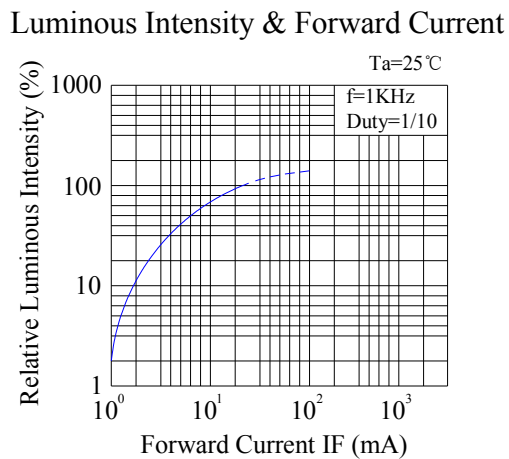
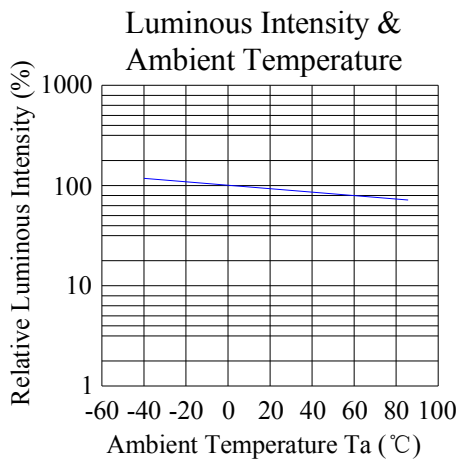
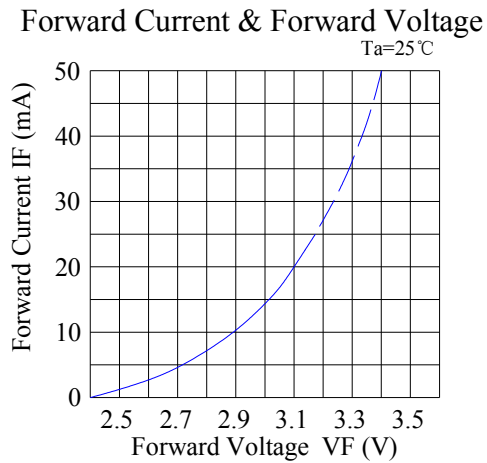
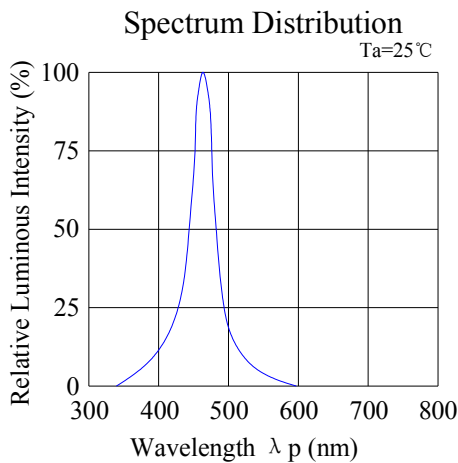

KW4-801ABB/KW4-801CBB



0.80 inch (20.40mm), Blue

Quadruple Digit 7-segment LED Display

Technical Data Sheet

Packing & Label Specifications:

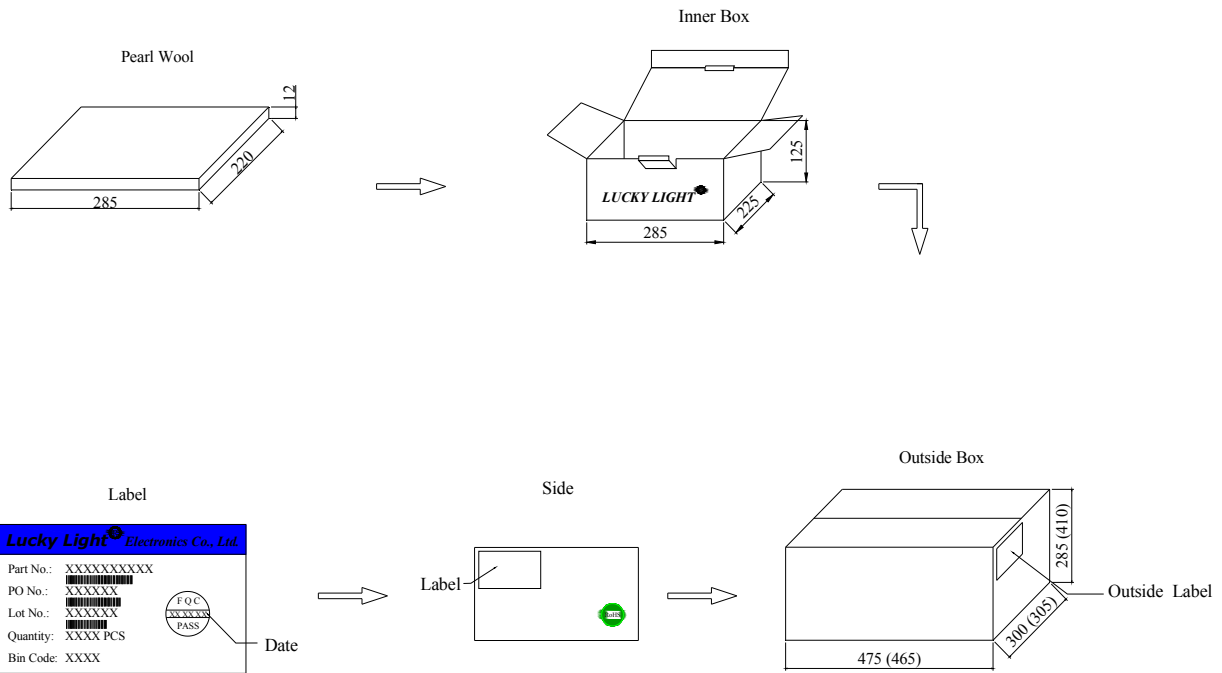

0.80 inch (20.40mm), Blue

Quadruple Digit 7-segment LED Display

Technical Data Sheet

Terms and conditions for the usage of this document:

- a. The information included in this document reflects representative usage scenarios and is intended for technical reference only.
- b. The part number, type, and specifications mentioned in this document are subject to future change and improvement without notice. Before production usage customer should refer to the latest datasheet for the updated specifications.
- c. When using the products referenced in this document, please make sure the product is being operated within the environmental and electrical limits specified in the datasheet. If customer usage exceeds the specified limits, LuckyLight will not be responsible for any subsequent issues.
- d. The information in this document applies to typical usage in consumer electronics applications. If customer's application has special reliability requirements or have life-threatening liabilities, such as automotive or medical usage, please consult with LuckyLight representative for further assistance.
- e. The contents and information of this document may not be reproduced or re-transmitted without permission by LuckyLight.

f. Over-current-proof

Customer must apply resistors for protection, otherwise slight voltage shift will cause big current change (Burn out will happen).

g. Storage

1. Before opening the package, the LEDs should be kept at 30°C or less and 80%RH or less.
2. The LEDs should be used within a year.
3. After opening the package, the LEDs should be kept at 30°C or less and 60%RH or less.

h. ESD (Electrostatic Discharge)

Static Electricity or power surge will damage the LED. Suggestions to prevent ESD damage:

I Use of a conductive wrist band or anti-electrostatic glove when handling these LEDs.

I All devices, equipment, and machinery must be properly grounded.

I Work tables, storage racks, etc. should be properly grounded.

Technical Data Sheet

Through Hole Display Mounting Method

Lead Forming:

1. Do not bend the component leads by hand without proper tools.
2. The leads should be bent by clinching the upper part of the lead firmly such that the bending force is not exerted on the plastic body.



Installation:

1. The installation process should not apply stress to the lead terminals.
2. When inserting for assembly, ensure the terminal pitch matches the substrate board's hole pitch to prevent spreading or pinching the lead terminals.

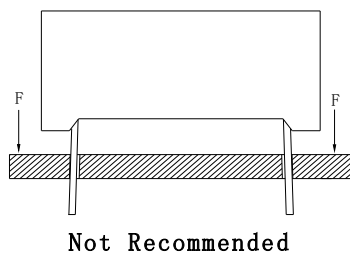

3. The component shall be placed at least 5mm from edge of PCB to avoid damage caused excessive heat during wave soldering.

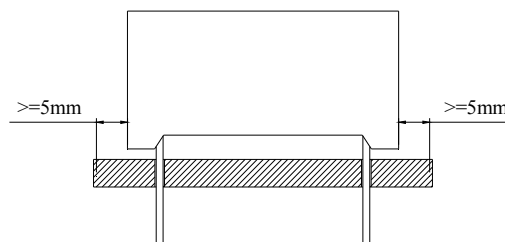

Technical Data Sheet

Recommended Wave Soldering Profiles



Notes:

1. Recommend pre-heat temperature of 105°C or less (as measured with a thermocouple attached to the LED pins) prior to immersion in the solder wave with a maximum solder bath temperature of 260°C.
2. Peak wave soldering temperature between 245°C~255°C for 3 sec (5 sec max).
3. Do not apply stress to the epoxy resin while the temperature is above 85°C.
4. Fixtures should not incur stress on the component when mounting and during soldering process.
5. SAC 305 solder alloy is recommended.
6. No more than one wave soldering pass.
7. During wave soldering, the PCB top-surface temperature should be kept below 105°C.

Soldering General Notes:

1. Through-hole displays are incompatible with reflow soldering.
2. If components will undergo multiple soldering processes, or other processes where the components may be subjected to intense heat, please check with luckyLight for compatibility.

0.80 inch (20.40mm), Blue

Quadruple Digit 7-segment LED Display

Technical Data Sheet

Cleaning:

1. Mild “no-clean” fluxes are recommended for use in soldering.
2. If cleaning is required, luckylight recommends to wash components with water only.
Do not use harsh organic solvents for cleaning because they may damage the plastic parts.
3. The cleaning process should take place at room temperature and the devices should not be washed for more than one minute.
4. When water is used in the cleaning process, immediately remove excess moisture from the component with forced-air drying afterwards.

Circuit Design Notes:

1. Protective current-limiting resistors may be necessary to operate the LEDs within the specified range.
2. LEDs mounted in parallel should each be placed in series with its own current-limiting resistor.

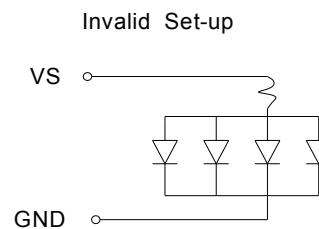
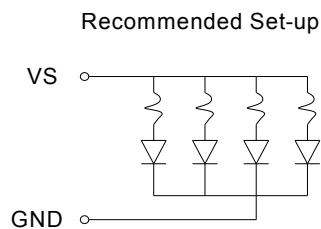

3. The driving circuit should be designed to protect the LED against reverse voltages and transient voltage spikes when the circuit is powered up or shut down.
4. The safe operating current should be chosen after considering the maximum ambient temperature of the operating environment.
5. Prolonged reverse bias should be avoided, as it could cause metal migration, leading to an increase in leakage current or causing a short circuit.