

KW1-S561AGB-G5

14.22mm (0.56 inch) Pure Green LED Display

Single Digit 7-segment Surface Mount LED Display

Technical Data Sheet

Features

- High reliability.
- Low power consumption.
- Excellent characters appearance.
- Evenly lighted segments.
- Packaged in tape and reel for SMT manufacturing.
- The thickness is thinner than traditional through-hole LED display.
- I.C compatible.
- RoHS compliant.

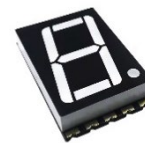

Descriptions

- The KW1-S561AGB-G5 is a 14.22mm (0.56inch) digit height surface mount 7-segment LED display.
- The display provides excellent reliability in bright ambient light.
- The device is available as either common anode or common cathode.
- The device is made with white diffused segments and black surface.

Applications

- Home and smart appliances.
- Instrument panels.
- Display time and digital combination.
- Test and measurement equipment.
- Control units.

Device Selection Guide

Part No.	Emitting Color	Circuit Common
KW1-S561AGB-G5	Pure Green	Common Anode

KW1-S561AGB-G5

14.22mm (0.56 inch) Pure Green LED Display
Single Digit 7-segment Surface Mount LED Display
Technical Data Sheet

Package Dimension

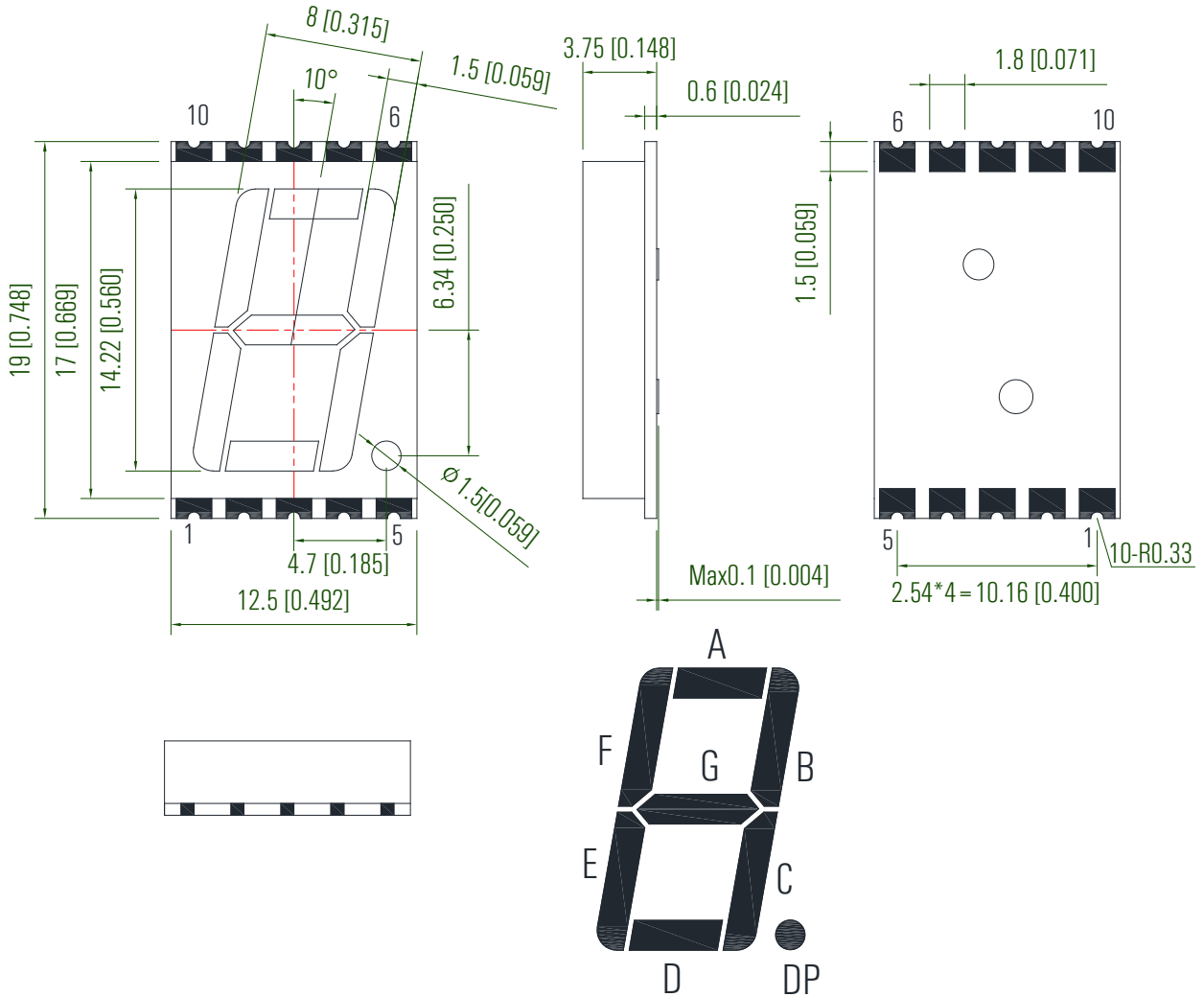

Notes:

1. All dimensions are in millimeters (inches).
2. Tolerance is ± 0.25 mm (.010") unless otherwise noted.
3. The gap between the reflector and PCB shall not exceed 0.25mm.

KW1-S561AGB-G5

14.22mm (0.56 inch) Pure Green LED Display
Single Digit 7-segment Surface Mount LED Display

Technical Data Sheet

Internal Circuit Diagram:

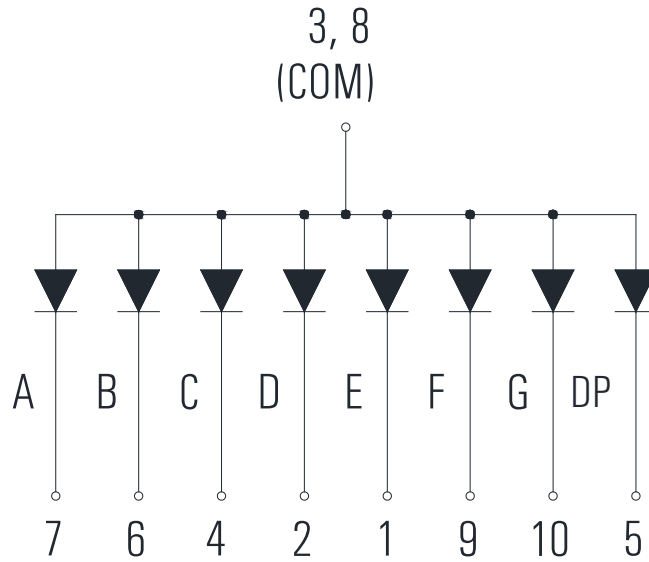

Technical Data Sheet

Absolute Maximum Ratings at Ta=25°C

Parameters	Symbol	Max	Unit
Power Dissipation (Per Chip)	P_d	64	mW
Peak Forward Current (Per Segment) (1/10 Duty Cycle, 0.1ms pulse width)	I_{FP}	40	mA
Forward Current (Per Segment)	I_F	20	mA
Reverse Voltage (Per Chip)	V_R	5	V
Operating Temperature Range	T_{opr}	-40°C to +80°C	
Storage Temperature Range	T_{stg}	-40°C to +85°C	
Soldering Temperature	T_{sld}	260°C for 5 Seconds	

Electrical Optical Characteristics at Ta=25°C

Parameters	Symbol	Min.	Typ.	Max.	Unit	Test Condition
Average Luminous Intensity	I_v	7.5	15.0	---	mcd	IF=5mA (Note a)
		15.0	30.0	---	mcd	IF=10mA (Note a)
Luminous Intensity Matching Ratio	I_{v-m}	---	---	2:1		IF=20mA
Peak Emission Wavelength	λ_p	---	520	---	nm	IF=20mA
Dominant Wavelength	λ_d	---	525	---	nm	IF=20mA (Note b)
Spectral Line Half-Width	$\Delta\lambda$	---	35	---	nm	IF=20mA
Forward Voltage (Per Segment)	V_F	---	2.9	3.2	V	IF=20mA (Note c)
Reverse Current (Per Segment)	I_R	---	---	50	μ A	VR=5V

Notes:

- Luminous intensity is measured with a light sensor and filter combination that approximates the CIE eye-response curve.
Tolerance of Luminous Intensity: $\pm 10\%$
- The dominant wavelength (λ_d) is derived from the CIE chromaticity diagram and represents the single wavelength which defines the color of the device.
- Tolerance of Forward Voltage: $\pm 0.1V$

Technical Data Sheet

Typical Electrical/Optical Characteristics Curves
(25°C Ambient Temperature Unless Otherwise)

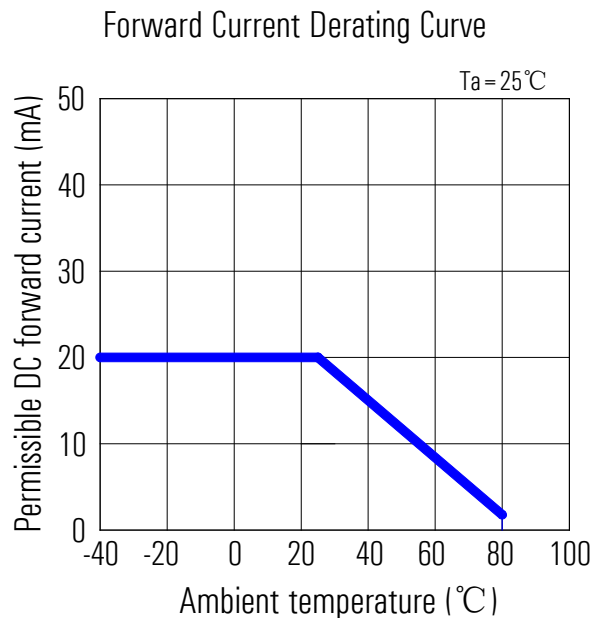
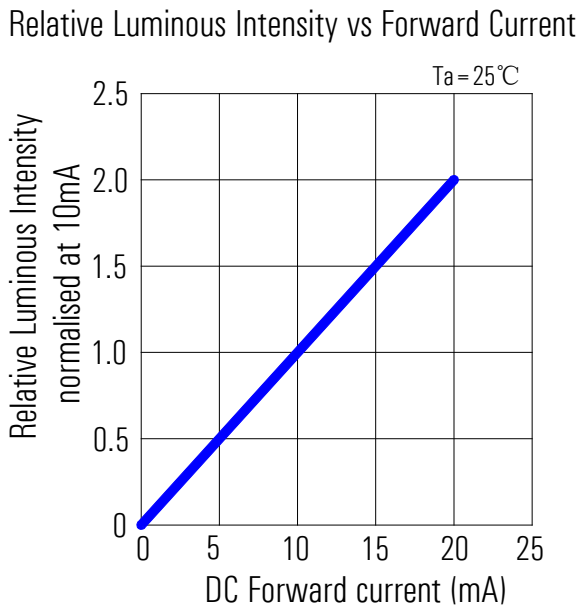
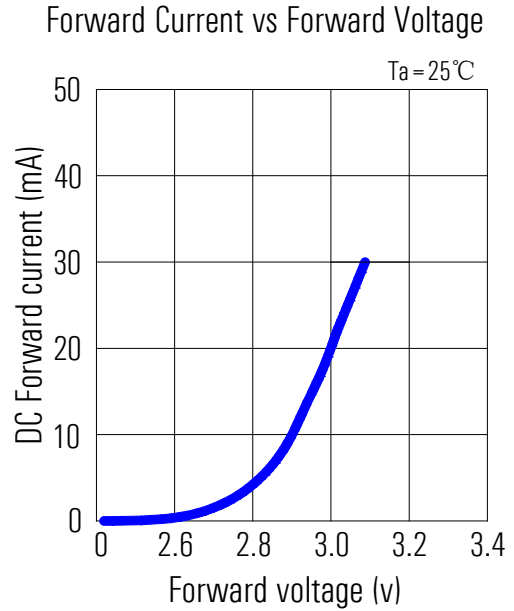
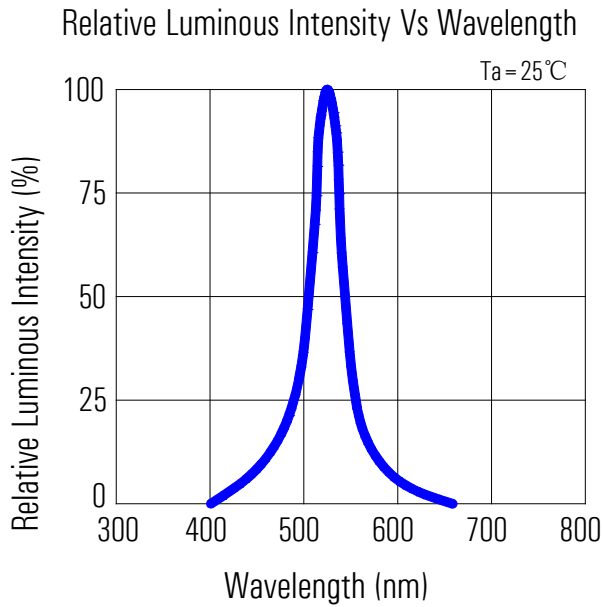

KW1-S561AGB-G5

14.22mm (0.56 inch) Pure Green LED Display
Single Digit 7-segment Surface Mount LED Display

Technical Data Sheet

Reel Dimensions (units: mm)

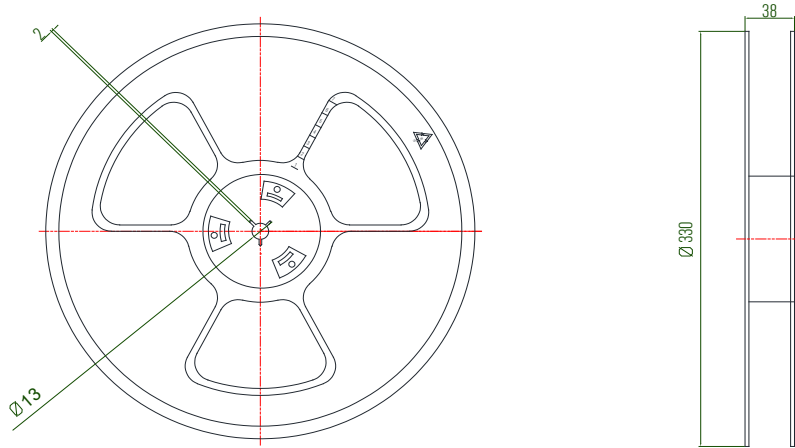

Tape Specifications (units: mm)

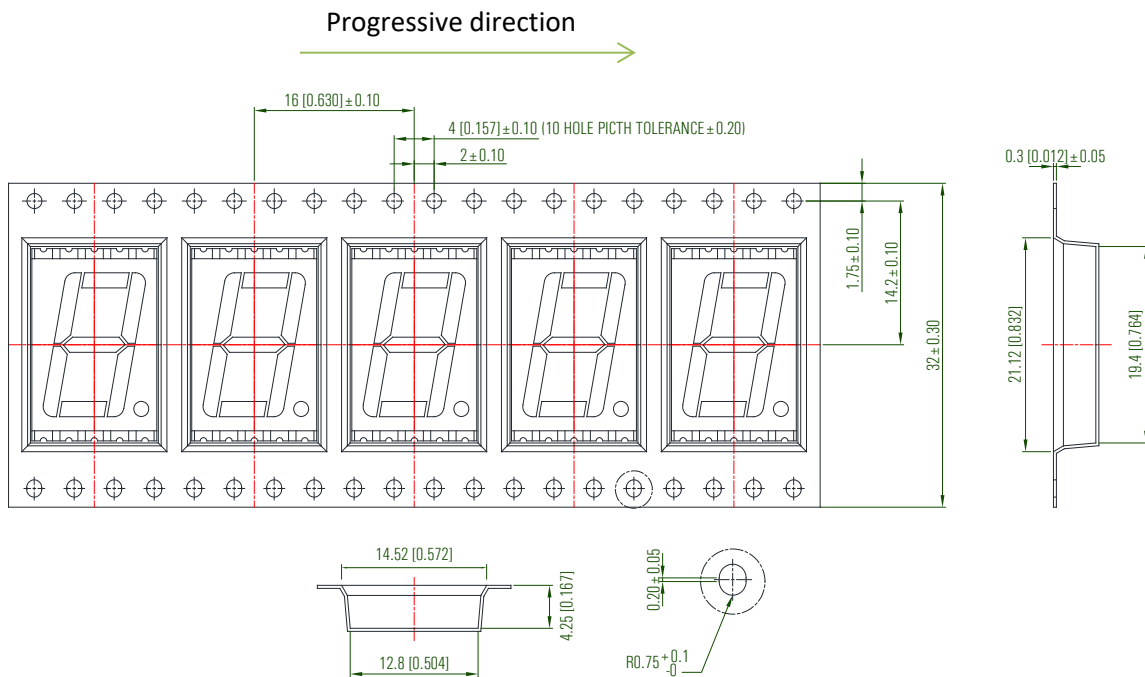

Note: Tolerances unless mentioned ± 0.25 mm.

Spec No.: Z-KW1-S561-MR

Issue No.: G-001-Rev-3

LuckyLight Electronics Co., Ltd

Copyright © 2022 LuckyLight All Rights Reserved

Date: August 18, 2022

E-mail: sales@luckylight.cn

https://www.luckylight.cn

Page:6 / 10

Technical Data Sheet

Packing & Label Specifications

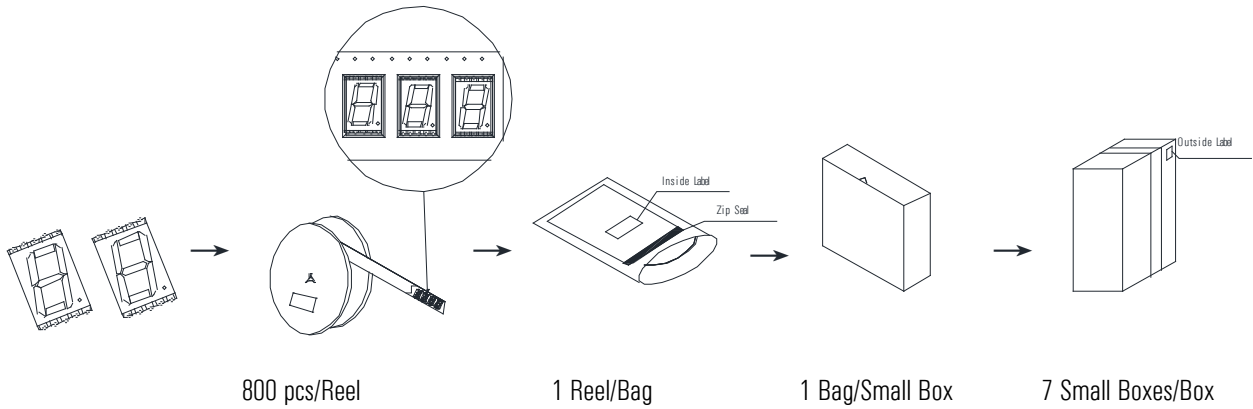

Precautions for Use

1. Caution in ESD

Static electricity and surge damages the LED. It is recommended to use a wrist band or anti-electrostatic glove when handling the LED. All devices equipment and machinery must be properly grounded.

2. Pb-Free Reflow Soldering Profile

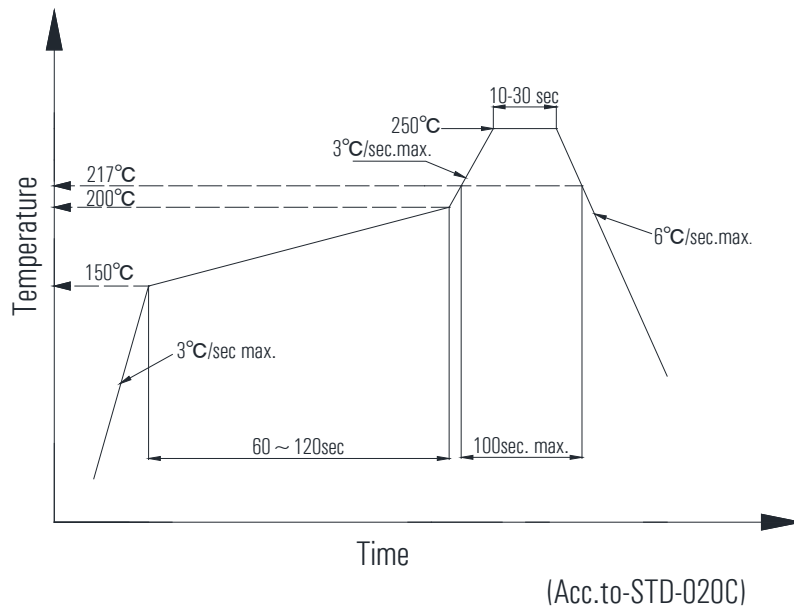

Technical Data Sheet

Notes:

Pre-heat		Other	
Temperature min	150°C	Liquidus Temperature	217°C
Temperature max	200 °C	Time above Liquidus Temperature	100sec.max
Time	60-120sec	Peak Temperature	250°C
Average ramp-up rate	3 °C/sec.max.	Ramp- Down Rate from Peak Temperature	6 °C/sec. max.
		Reflow times	1 time

- Reflow soldering is recommended. Other soldering methods are not recommended as they might cause damage to the product.
- All parameters are maximum body case temperature values and cannot be considered as a soldering profile. The body case temperature was measured by soldering a thermal couple to the soldering point of LEDs.
- No more than one reflow welding is recommended.

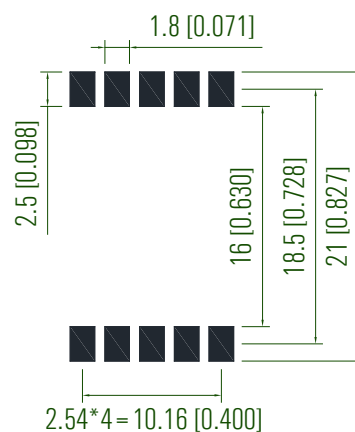
3. Recommended Soldering Pattern

4. Circuit Design Notes:

- Protective current-limiting resistors may be necessary to operate the LEDs within the specified range.
- LEDs mounted in parallel should each be placed in series with its own current-limiting resistor.
- The driving circuit should be designed to protect the LED against reverse voltages and transient voltage spikes when the circuit is powered up or shut down.
- The safe operating current should be chosen after considering the maximum ambient temperature of the operating environment.

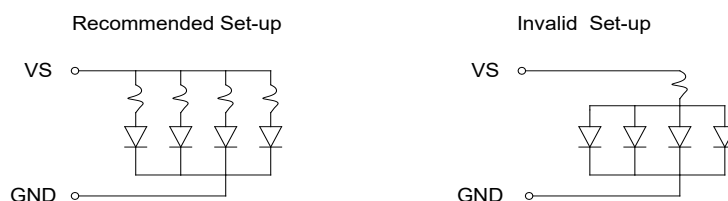
**Terms and conditions for the usage of this document**

- The information included in this document reflects representative usage scenarios and is intended for technical reference only.
- The part number, type, and specifications mentioned in this document are subject to future change and improvement without notice. Before production usage customer should refer to the latest datasheet for the updated specifications.
- When using the products referenced in this document, please make sure the product is being operated within the environmental and electrical limits specified in the datasheet. If customer usage exceeds the specified limits, LuckyLight will not be responsible for any subsequent issues.
- The information in this document applies to typical usage in consumer electronics applications. If customer's application has special reliability requirements or have life-threatening liabilities, such as automotive or medical usage, please consult with LuckyLight representative for further assistance.
- The contents and information of this document may not be reproduced or re-transmitted without permission by LuckyLight.
- The LEDs should be operated with forward bias. The driving circuit must be designed so that the LEDs are not subjected to forward or reverse voltage while it is off. If reverse voltage is continuously applied to the LEDs, it may cause migration resulting in LED damage.
- Sundries and stains are controlled within 0.2mm, which can be passed

KW1-S561AGB-G5

14.22mm (0.56 inch) Pure Green LED Display

Single Digit 7-segment Surface Mount LED Display

Technical Data Sheet

Revision History

Version	Date	Contents	Page
Version 1	March 16, 2009	Original Version	/
Version 2	December 10, 2012	Update the layout of the specifications data sheet	/
Version 3	August 18, 2022	Adjusted the packaging method and quantity of Tape Reel	6-7