

# KW1-501AGA/KW1-501CGA

0.50 inch (12.70mm), Yellow Green  
Single Digit 7-segment LED Display



## Technical Data Sheet

---

### Features:

- 0.50" (inch) digit height
- Low power consumption
- High reliability
- Excellent characters appearance
- Available in common cathode or common anode
- RoHS Compliant

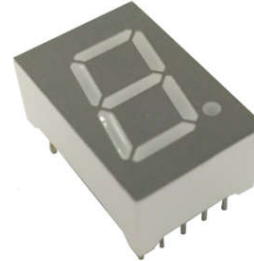

### Descriptions:

- The KW1-501AGA/KW1-501CGA is a 0.50 inch (12.70mm) height single digit display.
- The display provides excellent reliability in bright ambient light.
- The device is made with white segments and gray surface.

### Applications:

- Home appliances
- Instrument panels
- Digital readout displays
- Game console systems

### Device Selection Guide:

Part No.	Emitting Color	Polarity
KW1-501AGA	Yellow Green	Common Anode
KW1-501CGA	Yellow Green	Common Cathode

# KW1-501AGA/KW1-501CGA

0.50 inch (12.70mm), Yellow Green

Single Digit 7-segment LED Display



## Technical Data Sheet

### Package Dimension:

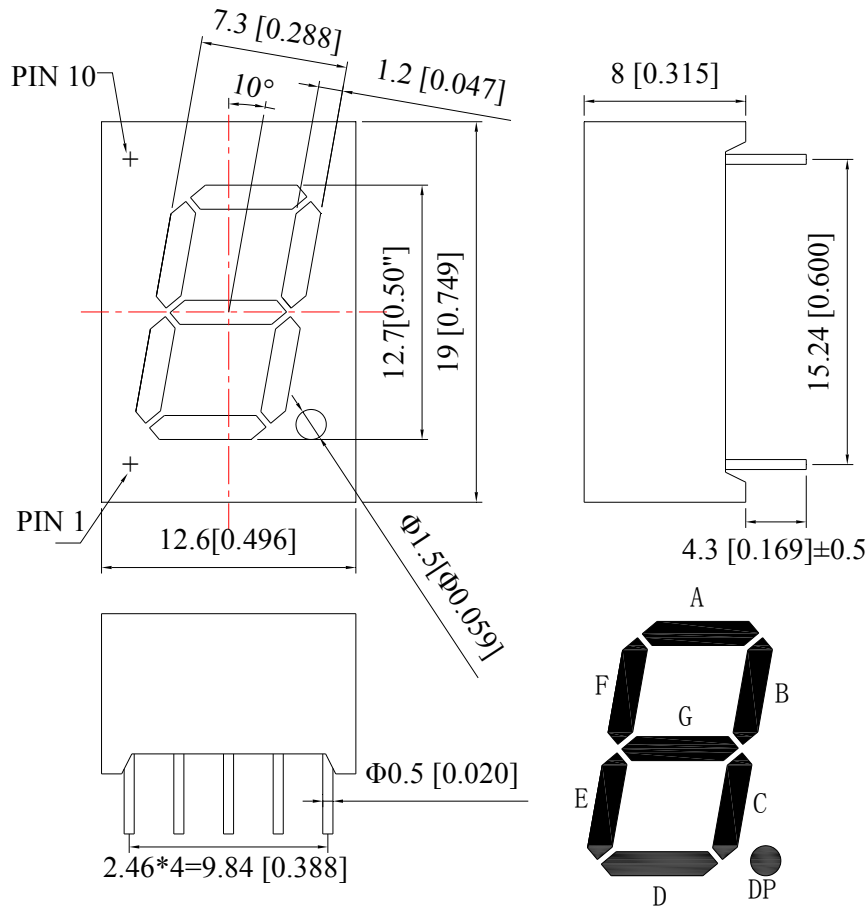

### Notes:

1. All dimensions are in millimeters (inches).
2. Tolerance is  $\pm 0.25$  mm (.010") unless otherwise noted.

Spec No.: W5011A/B

Issue No.: G-001-Rev-3

LuckyLight Electronics Co., Ltd

Copyright © 2017 LuckyLight All Rights Reserved

Date: 16-Mar-2017

E-mail: sales@luckylight.cn

http:// www.luckylight.cn

Page: 2 / 10

# KW1-501AGA/KW1-501CGA

0.50 inch (12.70mm), Yellow Green  
Single Digit 7-segment LED Display



## Technical Data Sheet

---

### Internal Circuit Diagram:

#### Internal Circuit Diagram (Common Anode)

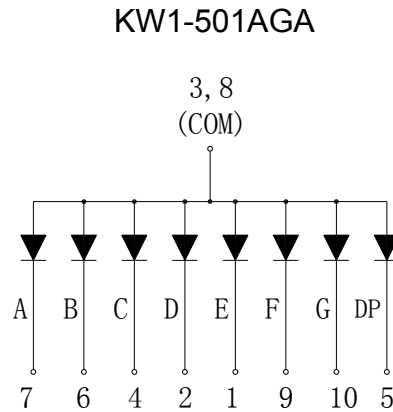

#### Internal Circuit Diagram (Common Cathode)

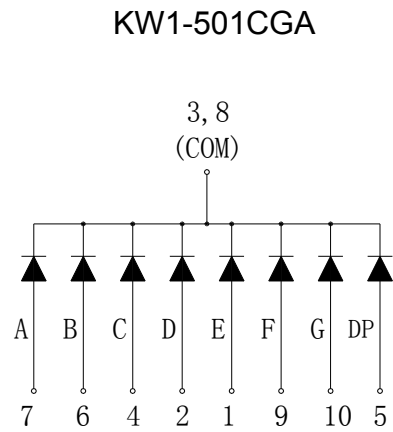

# KW1-501AGA/KW1-501CGA

0.50 inch (12.70mm), Yellow Green  
Single Digit 7-segment LED Display



## Technical Data Sheet

### Absolute Maximum Ratings at Ta=25°C

Parameters	Symbol	Max	Unit
Power Dissipation Per Segment	$P_d$	48	mW
Peak Forward Current Per Segment (1/10 Duty Cycle, 0.1ms Pulse Width)	$I_{FP}$	100	mA
Forward Current Per Segment	$I_F$	20	mA
Reverse Voltage Per Segment	$V_R$	5	V
Operating Temperature Range	$T_{opr}$	-40°C to +80°C	
Storage Temperature Range	$T_{stg}$	-40°C to +85°C	
Soldering Temperature	$T_{sld}$	260°C for 5 Seconds	

### Electrical Optical Characteristics at Ta=25°C

Parameters	Symbol	Min.	Typ.	Max.	Unit	Test Condition
Average Luminous Intensity	$I_v$	4.0	8.0	---	mcd	IF=10mA (Note a)
		8.0	16.0	---	mcd	IF=20mA (Note a)
Luminous Intensity Matching Ratio	$I_{v-m}$	---	---	2:1		IF=10mA
Peak Emission Wavelength	$\lambda_p$	---	575	---	nm	IF=20mA
Dominant Wavelength	$\lambda_d$	---	572	---	nm	IF=20mA (Note b)
Spectral Line Half-Width	$\Delta\lambda$	---	20	---	nm	IF=20mA
Forward Voltage Per Segment	$V_F$	---	2.0	2.4	V	IF=20mA
Reverse Current Per Segment	$I_R$	---	---	50	$\mu A$	VR=5V

#### Notes:

- Luminous intensity is measured with a light sensor and filter combination that approximates the CIE eye-response curve.
- The dominant wavelength ( $\lambda_d$ ) is derived from the CIE chromaticity diagram and represents the single wavelength which defines the color of the device.

# KW1-501AGA/KW1-501CGA

0.50 inch (12.70mm), Yellow Green

Single Digit 7-segment LED Display



## Technical Data Sheet

### Typical Electrical / Optical Characteristics Curves

(25°C Ambient Temperature Unless Otherwise Noted)

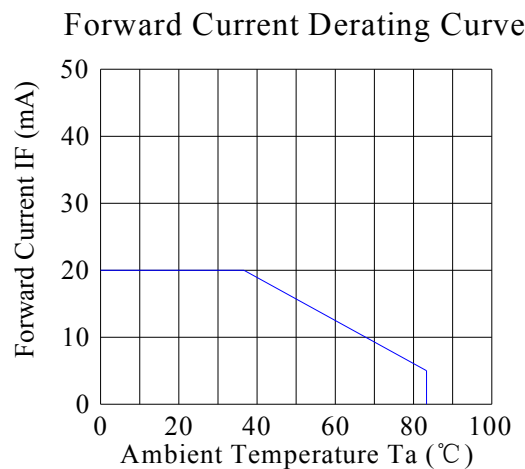
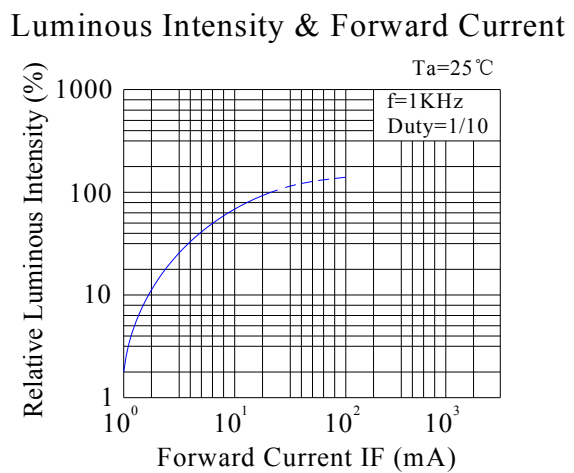
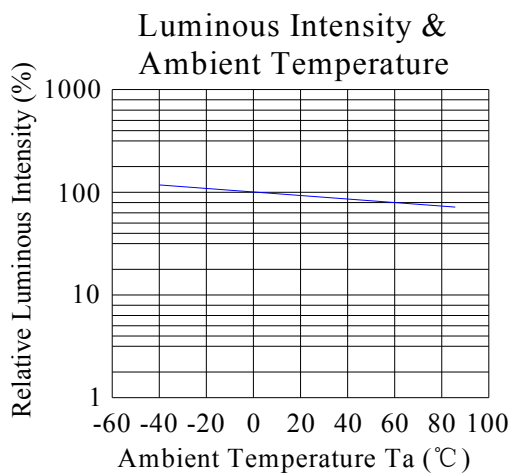
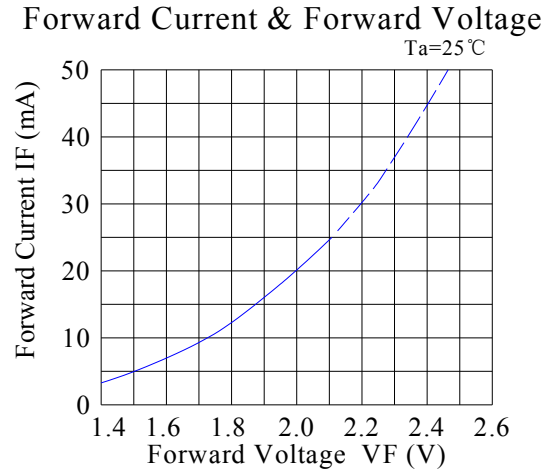
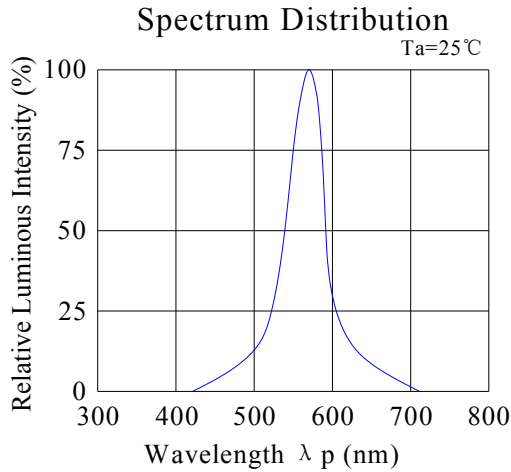

# KW1-501AGA/KW1-501CGA

0.50 inch (12.70mm), Yellow Green  
Single Digit 7-segment LED Display



## Technical Data Sheet

### Packing & Label Specifications:

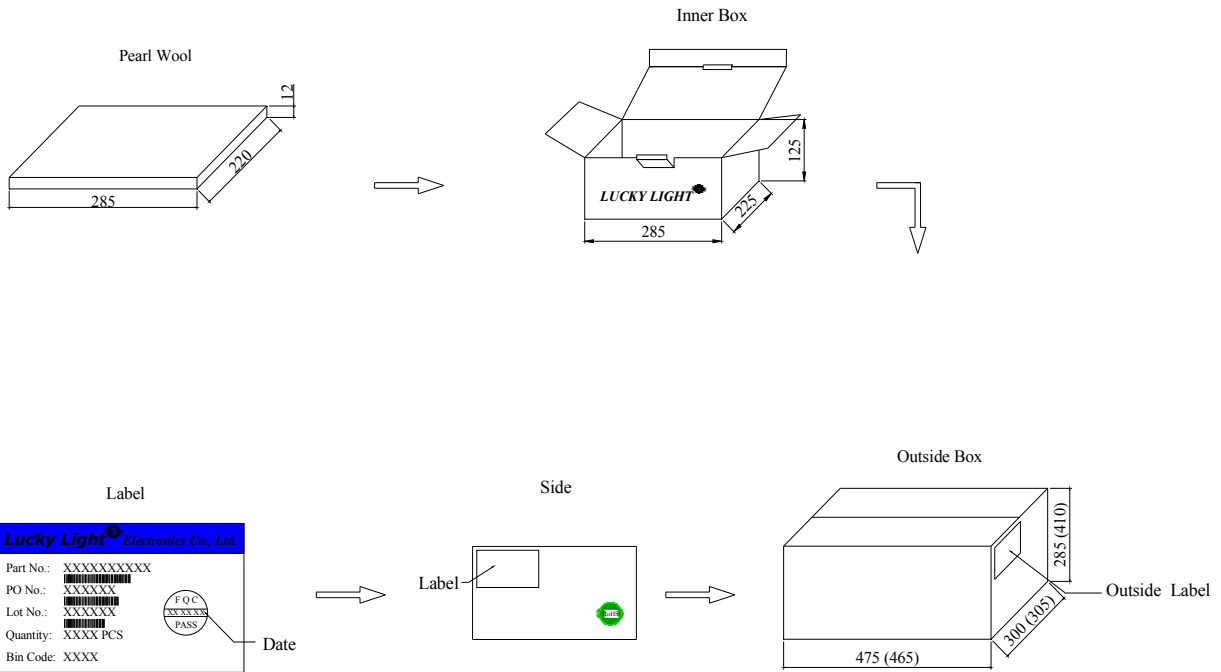

# KW1-501AGA/KW1-501CGA

0.50 inch (12.70mm), Yellow Green

Single Digit 7-segment LED Display



## Technical Data Sheet

---

### Terms and conditions for the usage of this document:

- a. The information included in this document reflects representative usage scenarios and is intended for technical reference only.
- b. The part number, type, and specifications mentioned in this document are subject to future change and improvement without notice. Before production usage customer should refer to the latest datasheet for the updated specifications.
- c. When using the products referenced in this document, please make sure the product is being operated within the environmental and electrical limits specified in the datasheet. If customer usage exceeds the specified limits, LuckyLight will not be responsible for any subsequent issues.
- d. The information in this document applies to typical usage in consumer electronics applications. If customer's application has special reliability requirements or have life-threatening liabilities, such as automotive or medical usage, please consult with LuckyLight representative for further assistance.
- e. The contents and information of this document may not be reproduced or re-transmitted without permission by LuckyLight.
- f. Over-current-proof  
Customer must apply resistors for protection, otherwise slight voltage shift will cause big current change (Burn out will happen).
- g. Storage
  1. Before opening the package, the LEDs should be kept at 30°C or less and 80%RH or less.
  2. The LEDs should be used within a year.
  3. After opening the package, the LEDs should be kept at 30°C or less and 60%RH or less.

# KW1-501AGA/KW1-501CGA

0.50 inch (12.70mm), Yellow Green

Single Digit 7-segment LED Display



## Technical Data Sheet

### Through Hole Display Mounting Method

#### Lead Forming:

1. Do not bend the component leads by hand without proper tools.
2. The leads should be bent by clinching the upper part of the lead firmly such that the bending force is not exerted on the plastic body.

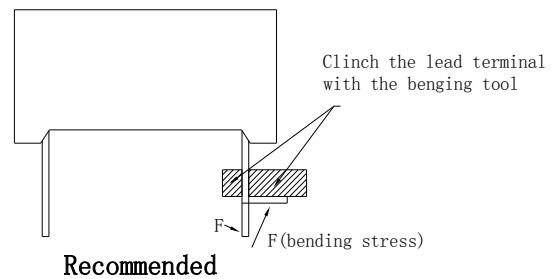
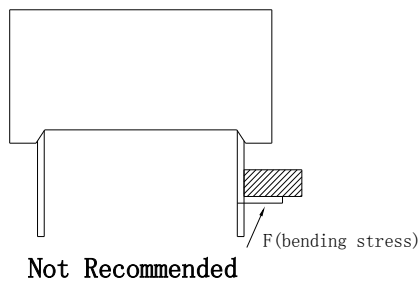

#### Installation:

1. The installation process should not apply stress to the lead terminals.
2. When inserting for assembly, ensure the terminal pitch matches the substrate board's hole pitch to prevent spreading or pinching the lead terminals.

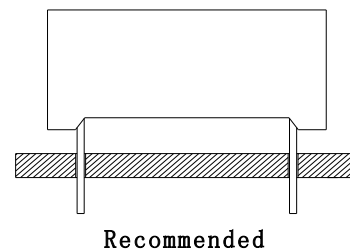
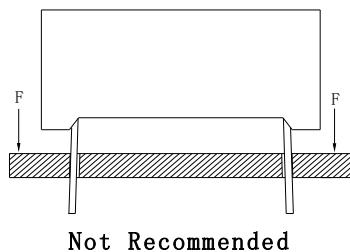

3. The component shall be placed at least 5mm from edge of PCB to avoid damage caused excessive heat during wave soldering.

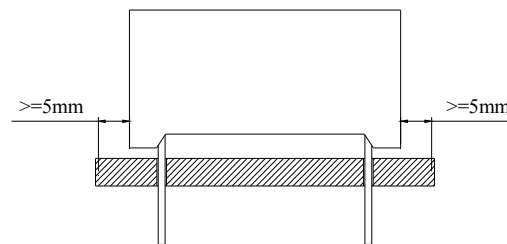
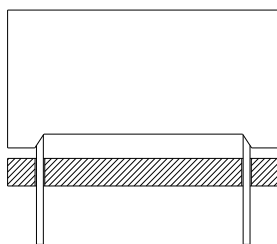



## KW1-501AGA/KW1-501CGA

0.50 inch (12.70mm), Yellow Green

Single Digit 7-segment LED Display

**LuckyLight**

## Technical Data Sheet

### Recommended Wave Soldering Profiles

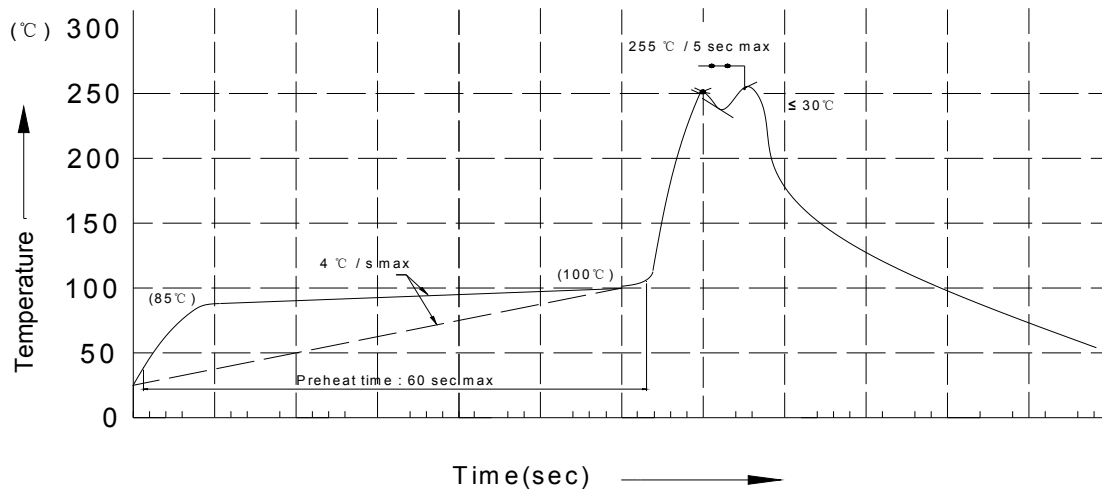

### Notes:

1. Recommend pre-heat temperature of 105°C or less (as measured with a thermocouple attached to the LED pins) prior to immersion in the solder wave with a maximum solder bath temperature of 260°C.
2. Peak wave soldering temperature between 245°C~255°C for 3 sec (5 sec max).
3. Do not apply stress to the epoxy resin while the temperature is above 85°C.
4. Fixtures should not incur stress on the component when mounting and during soldering process.
5. SAC 305 solder alloy is recommended.
6. No more than one wave soldering pass.
7. During wave soldering, the PCB top-surface temperature should be kept below 105°C.

### Soldering General Notes:

1. Through-hole displays are incompatible with reflow soldering.
2. If components will undergo multiple soldering processes, or other processes where the components may be subjected to intense heat, please check with luckyLight for compatibility.

## KW1-501AGA/KW1-501CGA

0.50 inch (12.70mm), Yellow Green  
Single Digit 7-segment LED Display

**LuckyLight**

## Technical Data Sheet

---

### Cleaning:

1. Mild “no-clean” fluxes are recommended for use in soldering.
2. If cleaning is required, luckyLight recommends to wash components with water only.  
Do not use harsh organic solvents for cleaning because they may damage the plastic parts.
3. The cleaning process should take place at room temperature and the devices should not be washed for more than one minute.
4. When water is used in the cleaning process, immediately remove excess moisture from the component with forced-air drying afterwards.

### Circuit Design Notes:

1. Protective current-limiting resistors may be necessary to operate the LEDs within the specified range.
2. LEDs mounted in parallel should each be placed in series with its own current-limiting resistor.

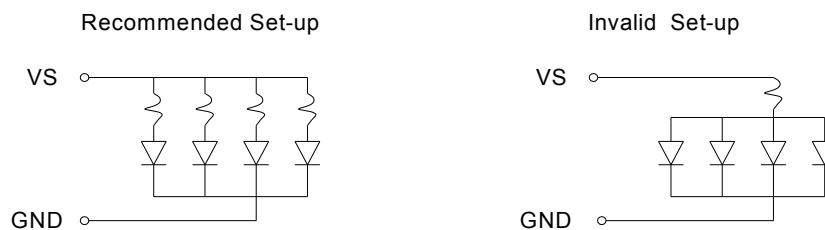

3. The driving circuit should be designed to protect the LED against reverse voltages and transient voltage spikes when the circuit is powered up or shut down.
4. The safe operating current should be chosen after considering the maximum ambient temperature of the operating environment.
5. Prolonged reverse bias should be avoided, as it could cause metal migration, leading to an increase in leakage current or causing a short circuit.