

C3535BC-B4H-Q15

3.5x3.5mm,Blue LED

Ceramic Package Top View LED Light Source

Technical Data Sheet

Features:

- Small SMT ceramic package with high efficiency.
- Low thermal resistance
- Soldering method: SMT.
- Binning Parameters: Brightness, Forward.
- Voltage, Wavelength and Chromaticity.
- Matches ANSI binning.
- Reflow soldering with JEDEC JSTD-020C compatible.
- The product itself will remain within RoHS compliant Version.

Descriptions:

- The C3535 series is a surface-mount high-power device featuring high brightness combined with a compact size that is suitable for all kinds of lighting applications such as general illumination, flash, spot, signal, industrial and commercial lighting. The thermal pad of this device is electrically isolated providing convenience in thermal and electrical design.
- The C3535 series is one of the most promising devices in LuckyLight's high power product offering and is ready to face the challenges of today's Solid-State Lighting requirements.

Applications:

- General Lighting.
- General luminaire.
- Decorative and Entertainment Lighting.
- Exterior and Interior Automotive.
- Agriculture Lighting.
- Bulb.

C3535BC-B4H-Q15

3.5x3.5mm, Blue LED

Ceramic Package Top View LED Light Source



Technical Data Sheet

Part No.	Emitting Color	Lens Color
C3535BC-B4H-Q15	Blue	Water Clear

Package Dimension:

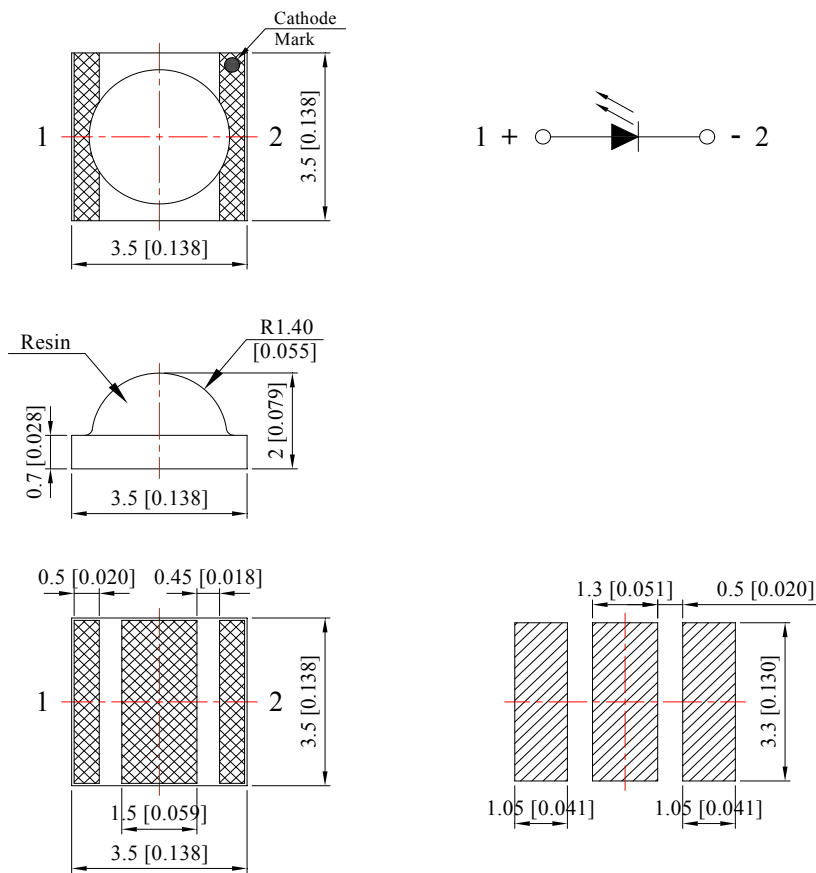

Notes:

1. All dimensions are in millimeters (inches).
2. Tolerance is ± 0.25 mm (.010") unless otherwise noted.

C3535BC-B4H-Q15

3.5x3.5mm,Blue LED

Ceramic Package Top View LED Light Source



Technical Data Sheet

Absolute Maximum Ratings at Ta=25°C

Parameters	Symbol	Max	Unit
Power Dissipation	Pd	1	W
Peak Forward Current ^(a)	IFP	500	mA
DC Forward Current	IF	350	mA
Reverse Voltage	VR	5	V
Electrostatic Discharge (HBM)	ESD	1000	V
LED Junction Temperature	Tj	120	°C
Operating Temperature Range	Topr	-40°C to +85°C	
Storage Temperature Range	Tstg	-40°C to +85°C	
Soldering Temperature	Tsld	260°C for 5 Seconds	

Note:

a.Pulse width ≤ 0.1ms, Duty ≤ 1/10

Electrical Optical Characteristics at Ta=25°C

Parameters	Symbol	Min.	Typ.	Max.	Unit	Test Condition
Luminous Flux ^(a)	Φ_v	15	25	---	Lm	IF=350mA
Viewing Angle	2 θ 1/2	---	120	---	Deg	IF=350mA
Peak Emission Wavelength	λ_p	---	468	---	nm	IF=350mA
Dominant Wavelength ^(b)	λ_d	---	470	---	nm	IF=350mA
Spectral Line Half-Width	$\Delta\lambda$	---	35	---	nm	IF=350mA
Forward Voltage ^(c)	VF	2.80	3.20	3.60	V	IF=350mA
Thermal Resistance	Rth j-s	---	10	---	°C/W	IF=350mA
Reverse Current	IR	---	---	50	μA	VR=5V

Notes:

- Luminous flux measurement tolerance: ±10%.
- Wavelength measurement tolerance: ±1nm
- Forward voltage measurement tolerance: ±0.1V

C3535BC-B4H-Q15

3.5x3.5mm,Blue LED

Ceramic Package Top View LED Light Source



Technical Data Sheet

Typical Electrical / Optical Characteristics Curves (25°C Ambient Temperature Unless Otherwise Noted)

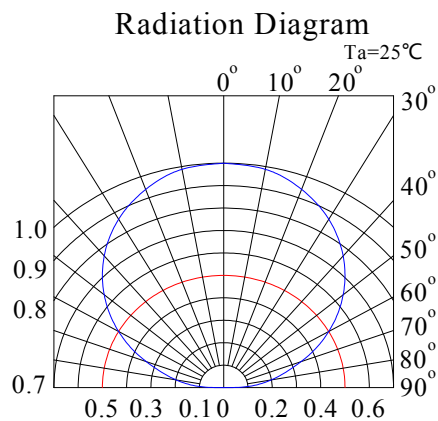
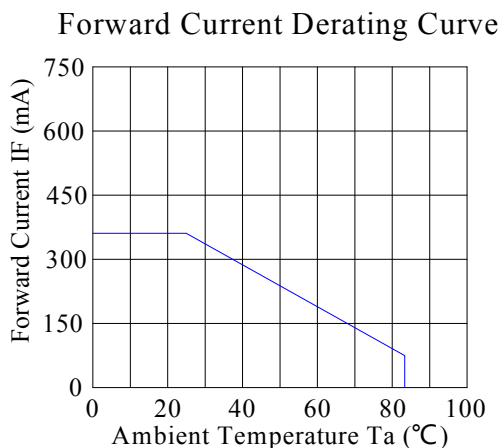
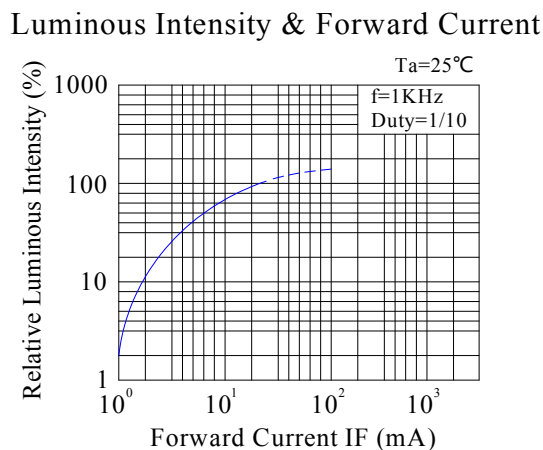
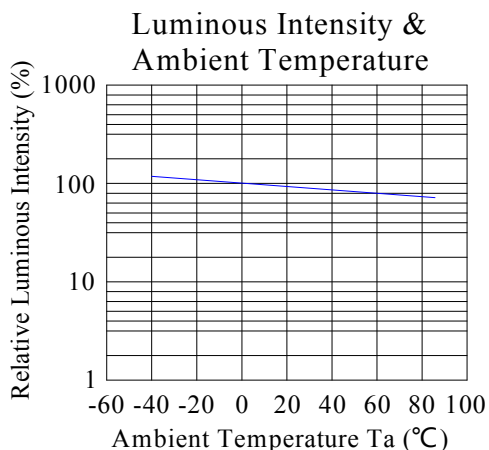
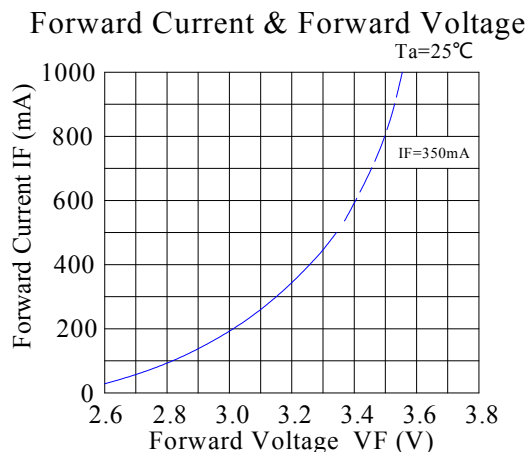
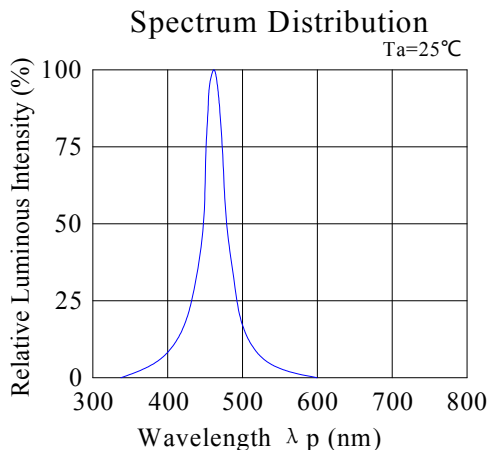

C3535BC-B4H-Q15

3.5x3.5mm, Blue LED

Ceramic Package Top View LED Light Source



Technical Data Sheet

Reel Dimensions:

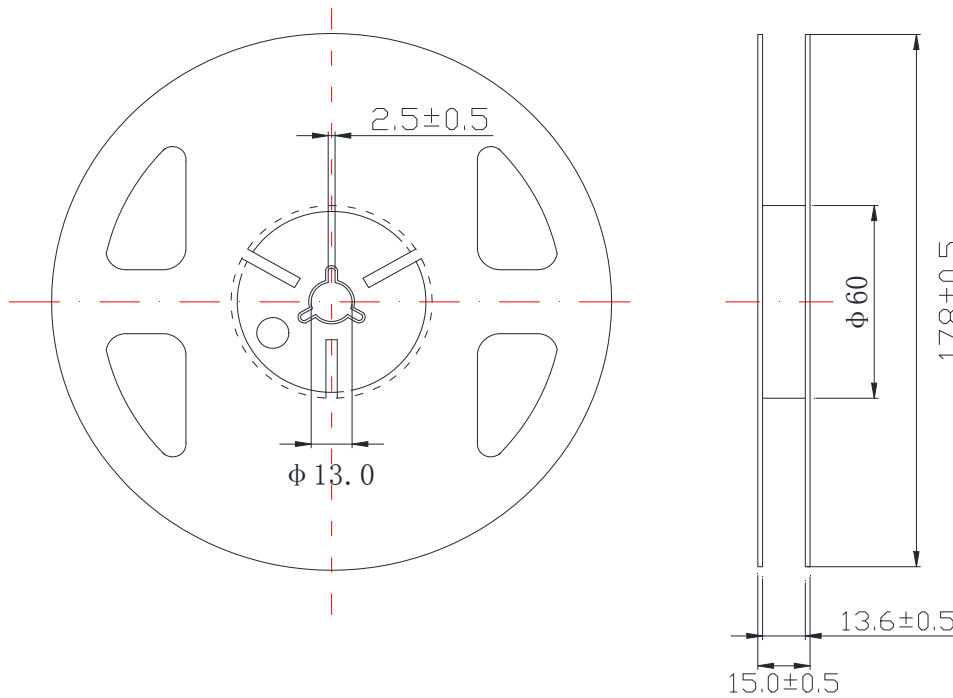

Carrier Tape Dimensions:

Loaded quantity 1000 pcs per reel.

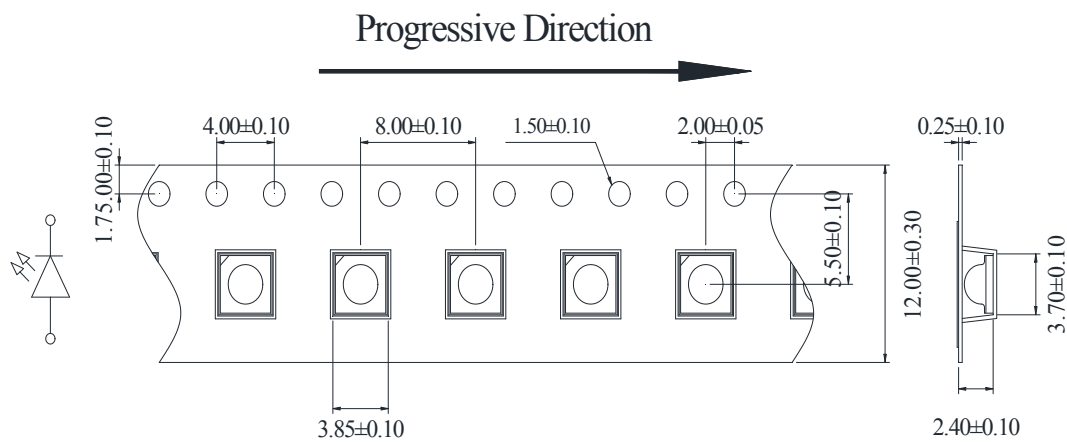

C3535BC-B4H-Q15

3.5x3.5mm,Blue LED

Ceramic Package Top View LED Light Source



Technical Data Sheet

Packing & Label Specifications:

Moisture Resistant Packaging:

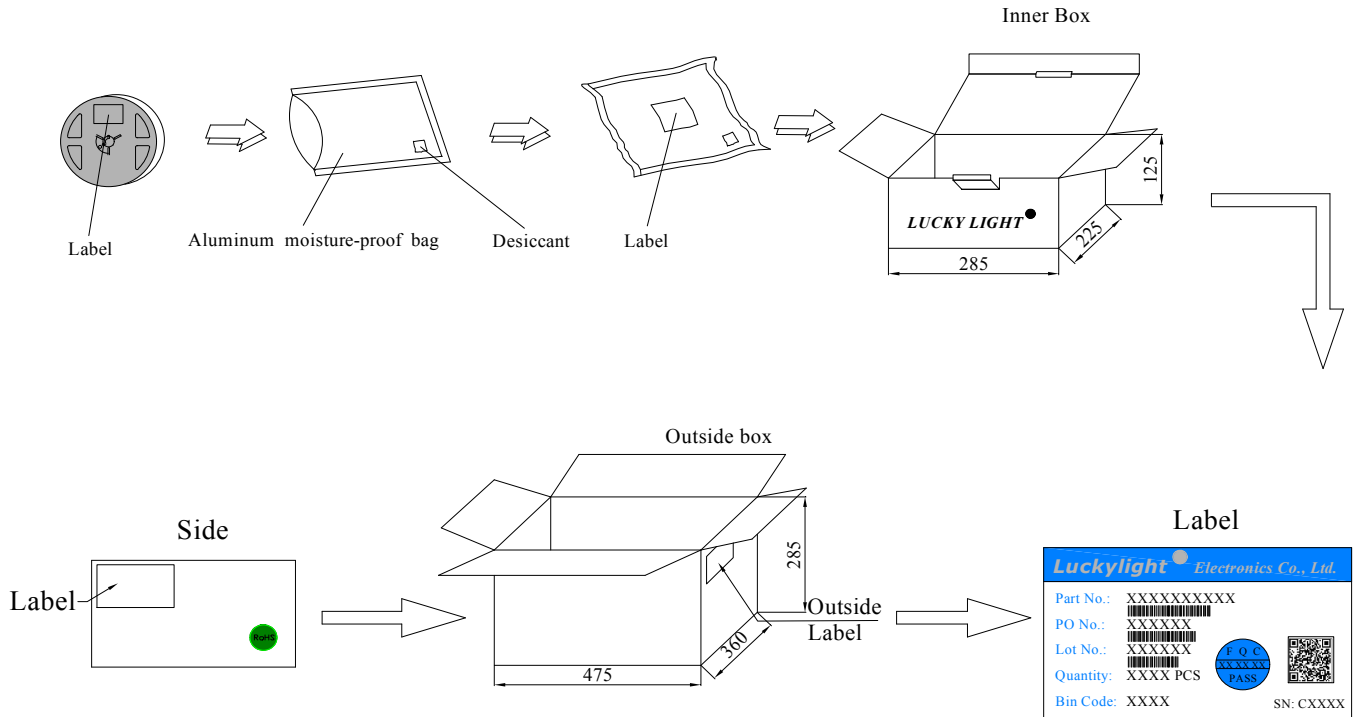

Spec No.: C3535

Issue No.: G-Rev-4

LuckyLight Electronics Co., Ltd

Copyright © 2022 LuckyLight All Rights Reserved

Date: 12-Sep-2022

E-mail: sales@luckylight.cn

http:// www.luckylight.cn

Page: 6 / 10

C3535BC-B4H-Q15

3.5x3.5mm,Blue LED

Ceramic Package Top View LED Light Source

Technical Data Sheet

CAUTIONS

1. Handling Precautions:

- 1.1. Handle the component along the side surfaces by using forceps or appropriate tools.
- 1.2. Do not directly touch or handle the silicone lens surface. It may damage the internal circuitry.
- 1.3. Do not stack together assembled PCBs containing exposed LEDs. Impact may scratch the silicone lens or damage the internal circuitry.

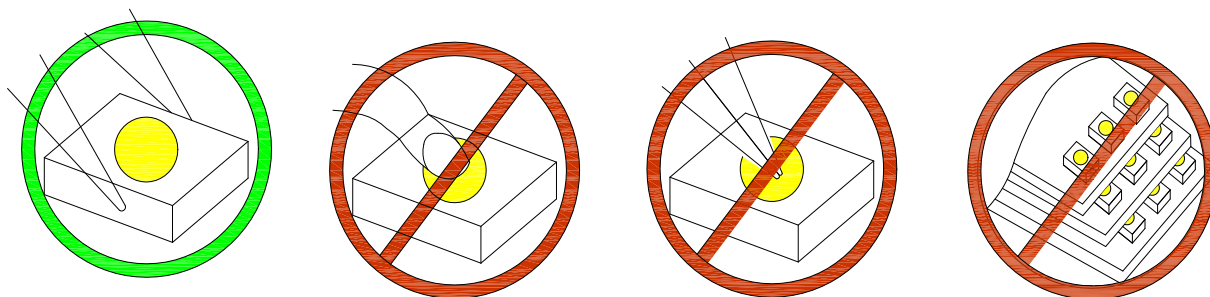

Compare to epoxy encapsulant that is hard and brittle, silicone is softer and flexible. Although its characteristic significantly reduces thermal stress, it is more susceptible to damage by external mechanical force. As a result, special handling precautions need to be observed during assembly using silicone encapsulated LED products. Failure to comply might lead to damage and premature failure of the LED.

2. Storage

- 2.1. Do not open moisture proof bag before the products are ready to use.
- 2.2. Before opening the package, the LEDs should be kept at 30°C or less and 60%RH or less.
- 2.3. The LEDs should be used within a year.
- 2.4. After opening the package, the LEDs should be kept at 30°C or less and 60%RH or less.
- 2.5. The LEDs should be used within 24 hours after opening the package.
- 2.6. If the moisture adsorbent material has fabled away or the LEDs have exceeded the storage time, baking treatment should be performed using the following conditions. Baking treatment: 65±5°C for 24 hours

C3535BC-B4H-Q15

3.5x3.5mm,Blue LED

Ceramic Package Top View LED Light Source



Technical Data Sheet

3. Soldering Condition

3.1. Pb-free solder temperature profile

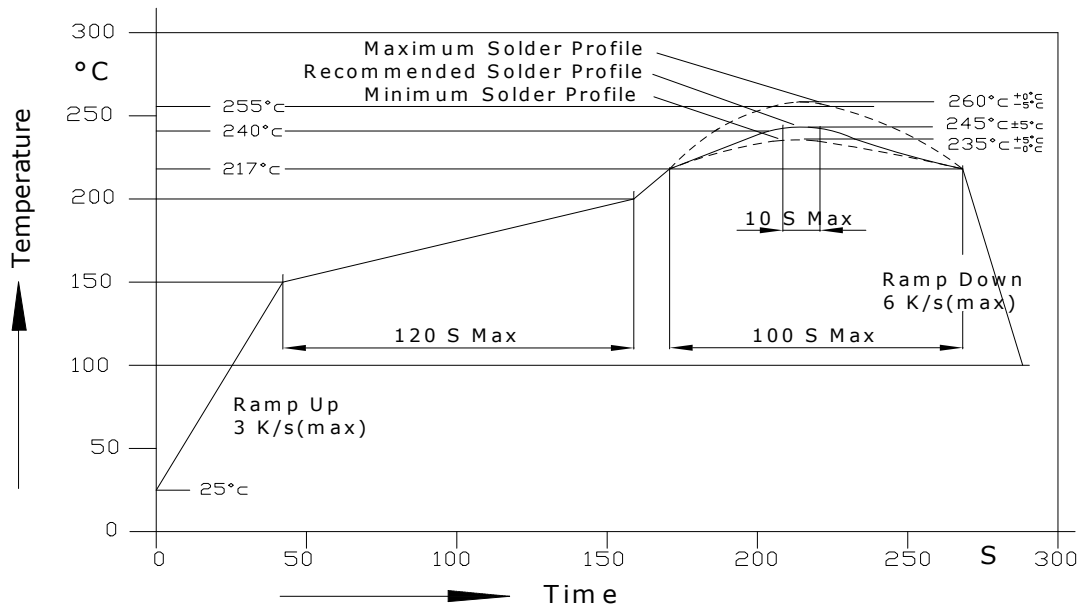

3.2. Reflow soldering should not be done more than two times.

3.3. When soldering, do not put stress on the LEDs during heating.

3.4. After soldering, do not warp the circuit board.

3.5. Recommended soldering conditions:

Reflow soldering		Soldering iron	
Pre-heat	150~200°C	Temperature	300°C Max.
Pre-heat time	120 sec. Max.	Soldering time	3 sec. Max.
Peak temperature	260°C Max.		(one time only)
Soldering time	10 sec. Max.(Max. two times)		

3.6. Because different board designs use different number and types of devices, solder pastes, reflow ovens, and circuit boards, no single temperature profile works for all possible combinations.

C3535BC-B4H-Q15

3.5x3.5mm,Blue LED

Ceramic Package Top View LED Light Source

Technical Data Sheet

However, you can successfully mount your packages to the PCB by following the proper guidelines and PCB-specific characterization.

4. Drive Method

4.1. An LED is a current-operated device. In order to ensure intensity uniformity on multiple LEDs connected in parallel in an application, it is recommended that a current limiting resistor be incorporated in the drive circuit, in series with each LED as shown in Circuit A below.

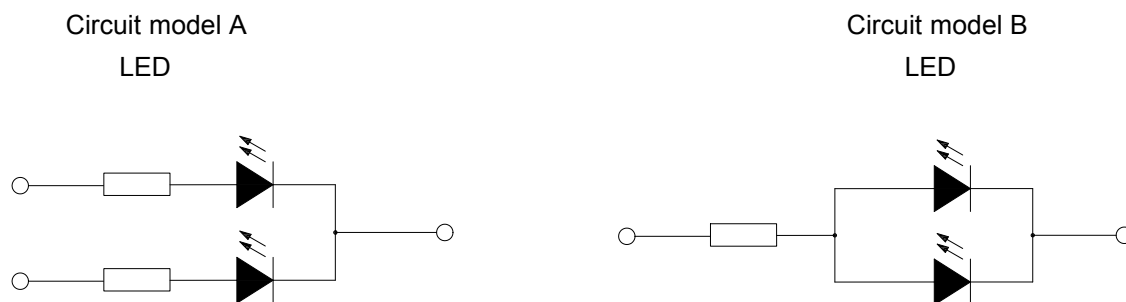

a. Recommended circuit.

b. The brightness of each LED might appear different due to the differences in the I-V characteristics of those LEDs.

5. ESD (Electrostatic Discharge):

Static Electricity or power surge will damage the LED. Suggestions to prevent ESD damage:

- Use of a conductive wrist band or anti-electrostatic glove when handling these LEDs.
- All devices, equipment, and machinery must be properly grounded.
- Work tables, storage racks, etc. should be properly grounded.
- Use ion blower to neutralize the static charge which might have built up on surface of the LED's plastic lens as a result of friction between LEDs during storage and handling.

ESD-damaged LEDs will exhibit abnormal characteristics such as high reverse leakage current, low forward voltage, or “no lightup” at low currents. To verify for ESD damage, check for “lightup” and V_f of the suspect LEDs at low currents. The V_f of “good” LEDs should be $>2.0V@0.1mA$ for InGaN product and $>1.4V@0.1mA$ for AlInGaP product.

C3535BC-B4H-Q15

3.5x3.5mm,Blue LED

Ceramic Package Top View LED Light Source

LuckyLight

Technical Data Sheet

Terms and conditions for the usage of this document

1. The information included in this document reflects representative usage scenarios and is intended for technical reference only.
2. The part number, type, and specifications mentioned in this document are subject to future change and improvement without notice. Before production usage customer should refer to the latest datasheet for the updated specifications.
3. When using the products referenced in this document, please make sure the product is being operated within the environmental and electrical limits specified in the datasheet. If customer usage exceeds the specified limits, LuckyLight will not be responsible for any subsequent issues.
4. The information in this document applies to typical usage in consumer electronics applications. If customer's application has special reliability requirements or have life-threatening liabilities, such as automotive or medical usage, please consult with LuckyLight representative for further assistance.
5. The contents and information of this document may not be reproduced or re-transmitted without permission by LuckyLight.